

# ANSYS AIM Learning Modules

## What is ANSYS AIM?

ANSYS AIM is a simulation package that offers single and multiphysics solutions for thermal, modal, structural, fluid, and electrical analyses. ANSYS AIM uses finite-element and related methods to solve the underlying governing equations and the associated problem-specific boundary conditions.

## List of Learning Modules

In this short course you will be taken through ANSYS AIM and learn how to solve a variety of problems. The learning modules lead the user through the steps involved in solving a selected problem or set of problems. We not only provide the solution steps but also the rationale behind them. It is worthwhile for you to understand the underlying concepts as you travel through the learning modules in order to be able to correctly apply ANSYS AIM to other situations that you may encounter. You would be ill-served by clicking through the learning modules in zombie-mode. Each learning module is followed by problems which are geared towards strengthening and reinforcing the knowledge and understanding gained in the learning modules. Working through the problem sets is an intrinsic part of the learning process and shouldn't be skipped.

## Analysis Using ANSYS AIM

The following ANSYS tutorials show you how to obtain a solution from scratch using *ANSYS AIM*.

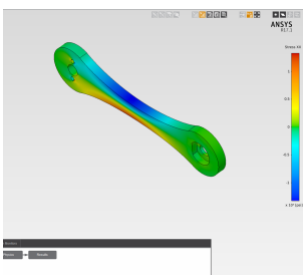
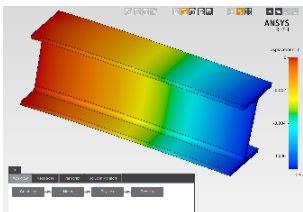
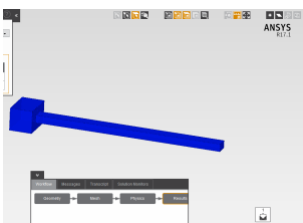
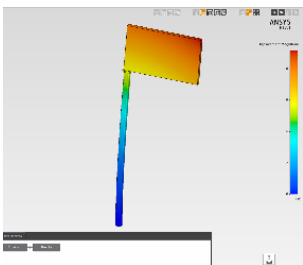
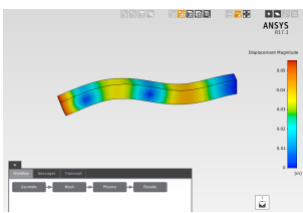
	<a href="#">Bike Crank</a>	Static Structural
	<a href="#">I Beam</a>	Static Structural
	<a href="#">Stress Due to Gravity</a>	Static Structural
	<a href="#">3D Sign Post</a>	Static Structural
	<a href="#">Cantilever Beam Modal Analysis</a>	Modal Analysis

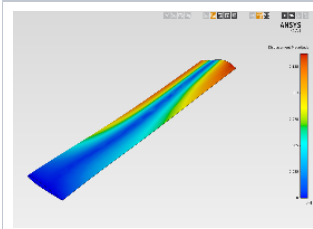

Modal Analysis of a Wing

Modal Analysis

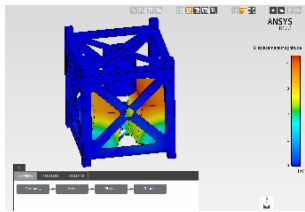

Satellite Modal Analysis

Modal Analysis

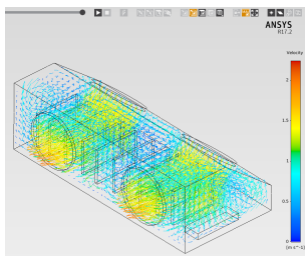

3D Convection through an Electronics Box

Fluid Flow

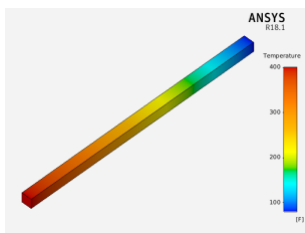

Heat Conduction in a Bar

Thermal

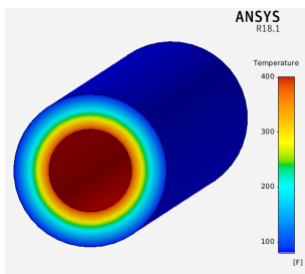

Heat Conduction in a Hollow Cylinder

Thermal

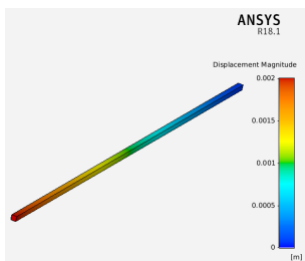

Thermal Stresses in a Bar

Thermal

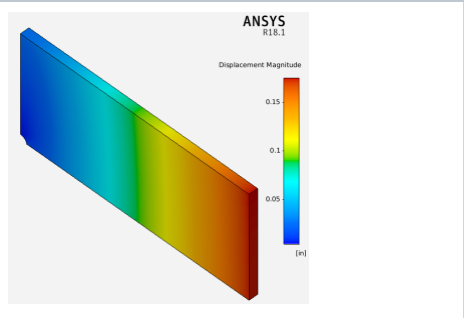
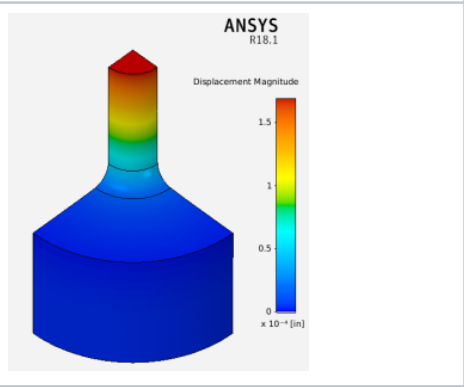
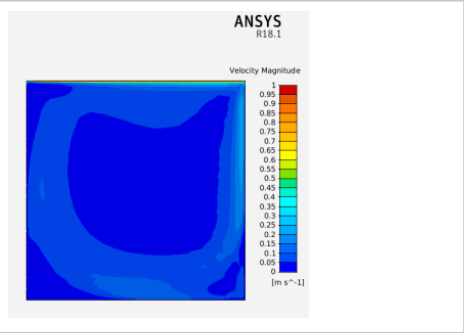
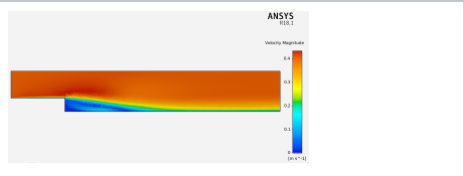
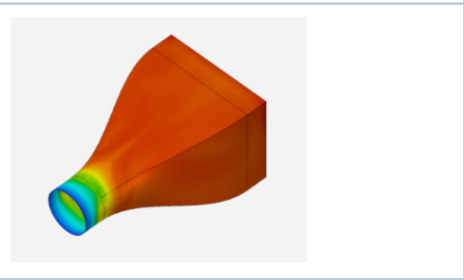
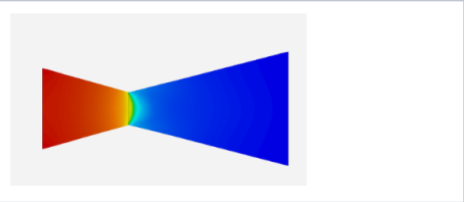
 <p>ANSYS R18.1 Displacement Magnitude 0.15 0.1 0.05 0 [m]</p>	<p>Plate with a Hole</p>	<p>Static Structural</p>
 <p>ANSYS R18.1 Displacement Magnitude 1.5 1 0.5 0 <math>\times 10^{-6}</math> [m]</p>	<p>Stepped Shaft in Axial Tension</p>	<p>Static Structural</p>
 <p>ANSYS R18.1 Velocity Magnitude 0.95 0.9 0.85 0.8 0.75 0.7 0.65 0.6 0.55 0.5 0.45 0.4 0.35 0.3 0.25 0.2 0.15 0.1 0.05 0 [m s<sup>-1</sup>]</p>	<p>3D Lid Driven Cavity - Cube</p>	<p>Fluid Flow</p>
 <p>ANSYS R18.1 Velocity Magnitude 0.15 0.1 0.05 0 [m s<sup>-1</sup>]</p>	<p>3D Backwards Facing Step</p>	<p>Fluid Flow</p>
 <p>ANSYS R18.1 Velocity Magnitude 0.15 0.1 0.05 0 [m s<sup>-1</sup>]</p>	<p>Fluid Flow Through a Transition Duct</p>	<p>Fluid Flow</p>
 <p>ANSYS R18.1 Velocity Magnitude 0.15 0.1 0.05 0 [m s<sup>-1</sup>]</p>	<p>Compressible Flow in a Nozzle</p>	<p>Fluid Flow</p>

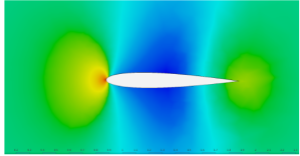
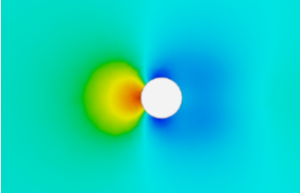
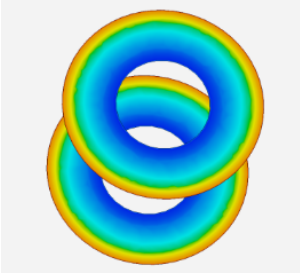
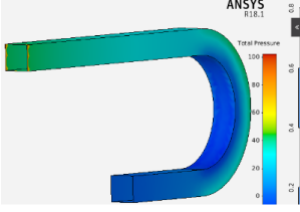
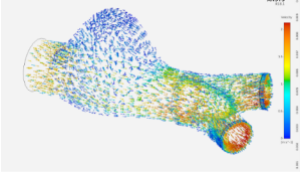
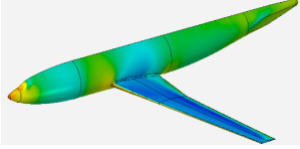
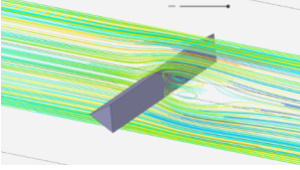
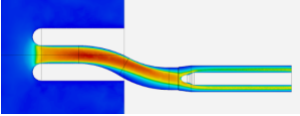
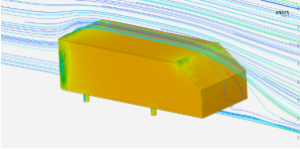
	<p>Compressible Flow Over an Airfoil</p>	<p>Fluid Flow</p>
	<p>Steady Flow over a Cylinder</p>	<p>Fluid Flow</p>
	<p>Taylor-Couette Flow between Rotating Cylinders</p>	<p>Fluid Flow</p>
	<p>Flow Through U-Duct</p>	<p>Fluid Flow</p>
	<p>Flow Through an Aortic Aneurysm</p>	<p>Fluid Flow</p>
	<p>Compressible Flow over a Wing-Body Junction</p>	<p>Fluid Flow</p>
	<p>Fluid Flow over a Bluff Body</p>	<p>Fluid Flow</p>
	<p>Flow in a S-Duct</p>	<p>Fluid Flow</p>
	<p>Flow over an Ahmed Body</p>	<p>Fluid Flow</p>

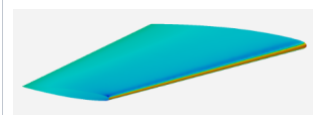

Transonic Flow over a Wing

Fluid Flow

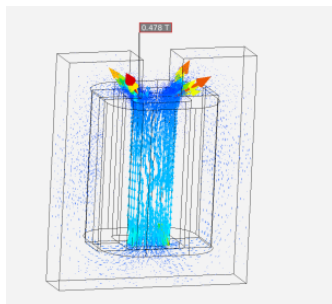

3D Static Force Computation

Magnetostatics

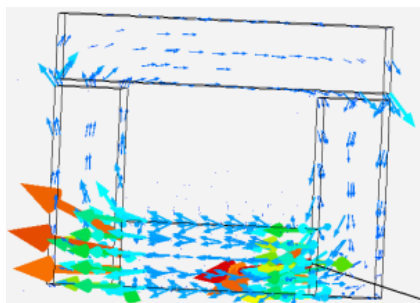

Permanent Magnetic Circuit with Air Gap

Magnetostatics

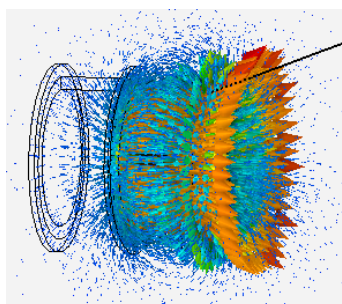

Forces in Permanent Magnets

Magnetostatics

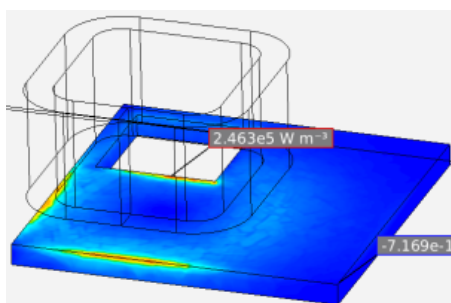

Eddy Current / Magnetic Frequency Response

Magnetics

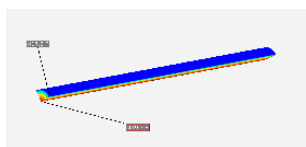

Thermal Analysis of an Electrical Wire

Electrical Conduction & Thermal