

# Linear Chemical Dose Controller Spring 2013 Final Report

Andrea Castro, Kent Chan, Saugat Ghimire

May 10, 2013

## Abstract

Accurate chemical dosing is an essential part of an AguaClara plant. Proper dosing is required for effective flocculation, sedimentation, filtration and disinfection. Coagulant (Poly Aluminum Chloride or Alum) and disinfectant (Chlorine) are chemicals used for dosing in an AguaClara plant. The linear chemical dose controller (LCDC) automatically maintains a linear relationship between the influent flow to the plant and the chemical dose. The plant operator therefore only adjusts the dose of coagulant based on the turbidity of the influent water. The Spring 2013 team has had two lever-arm assemblies fabricated by Hancock Precision based on the Fall 2012 design with additional improvements, such as having one end rod of the lever arm made up entirely of stainless steel instead of having a stainless steel rod placed over the aluminum rod and substituting anodization of the lever arm with powder coating, as the latter is more resistant to a corrosive environment. One unit has been sent to Honduras and the other is expected to be utilized in India. In addition to this, we have fabricated the manifold system out of PVC, a chemical resistant material. Through application of the orifice equation, we sized the constant head tank float valve orifice. Through application of a statics equation we determined that the float valve size could be reduced, allowing the use of a standard 5-gallon bucket for the constant head tank. We fabricated a constant head tank, suspended by a chain and attached to a turnbuckle, which can be easily adjusted during calibration. We have set up a fully functional unit of the coagulant dosing component of the dose controller in the lab, calibrated the unit, and tested the system at our maximum flow rate to compare how the system behaves compared to the model prediction and were below ten percent error. We created a detailed 3-D drawing in Google Sketchup of the current design of the linear chemical doser system including all appurtenances, in addition to creating a parts list, to facilitate future fabrications and assembly. This will not only be helpful for future groups to better understand the dose controller but also make it easier for the manufacturers to build it in the future. We also came up with ideas for protecting the entrance tank floats as water enters the plants at some locations in Honduras, to reduce dosing error.

## Introduction

Accurate chemical dosing in water treatment plants is imperative to ensure optimal efficiency of flocculation and disinfection. Linear chemical dose controller (LCDC) and linear flow orifice meter (LFOM) systems have been designed to allow plant operators to easily and reliably set and maintain the desired doses of coagulant and disinfectant. The combined system adjusts the chemical flow rate automatically in response to changes in plant flow rate to maintain the target chemical dose without requiring an electronic supervisory control and data acquisition (SCADA) system. A linear relationship between head loss and chemical flow in the LCDC is created by using the major head loss through a small diameter tube to control the chemical flow rate. The dose controller design minimizes minor losses through the chemical flow control system to reduce the error from non-linearities. The LCDC adjusts for plant flow rate changes by tracking the water level in the entrance tank to the water treatment plant. The LFOM maintains a linear relationship between height of water in the entrance tank and plant flow rate to create a linear input to the LCDC.

The new linear chemical dose controller design reduces the error associated both with the weight of the sliders in high flow rate plants and by reducing the non-linear effects of curved small diameter tubing. The new design also has the possibility of reducing the cost of chemical dosing by keeping the flow rates closer to the theoretical ideal rather than over dosing in the middle range of chemical flow rates.

Two lever arm assemblies have been fabricated based on the Fall 2012 design with additional improvements. One is available for testing in the laboratory, and the other has been transported to Honduras for implementation in a water treatment plant. The system in the lab has been sized and tested to supply coagulant for a design flow rate of 32 liters per second (L/s) in San Nicolás, Honduras. During Spring 2013, the lever arm assembly drawing was updated to reflect the latest design.

## Literature Review

### Mathematical Development

#### Governing Equations

The linear chemical dose controller (LCDC) uses major head loss and a constant head tank, which maintain a constant driving head elevation to regulate chemical flow to the water treatment plant. The relationship between major head loss and the chemical flow rate is given by the Hagen-Poiseuille Equation, Equation 1. The chemical flow rate ( $Q_C$ ) is a function of the major head loss ( $h_f$ ), the diameter of the tube ( $D_{Tube}$ ), the kinematic viscosity of the solution being used ( $\nu$ ) and the length of the small diameter tube ( $L_{Tube}$ ).

$$Q_C = \frac{h_f g \pi D_{Tube}^4}{128 \nu L_{Tube}} \quad (1)$$

The Hagen-Poiseuille Equation assumes that the chemical flow used is laminar (see Spring 2011 Final Report, Introduction to Current Research section for an explanation on how this laminar flow is ensured), viscous and incompressible. This equation also assumes that the flow in the tube passes through a constant, circular cross-section that is significantly longer than its given diameter. When the Hagen-Poiseuille equation is rearranged in regards to the major head loss ( $h_f$ ), one can see that this variable increases proportionally as the length of the small diameter tube ( $L_{Tube}$ ) is increased as shown in Equation 2.

$$h_f = \frac{128Q_C\nu L_{Tube}}{g\pi D_{Tube}^4} \quad (2)$$

The total head loss through the system ( $H_{Total}$ ) is the sum of the major ( $h_f$ ) and minor ( $h_e$ ) head losses. Major losses are due to viscous shear on the pipe walls whereas minor losses are due to various flow expansions as shown in Equation 3.

$$H_{Total} = h_f + h_e \quad (3)$$

Substituting equations for major and minor losses results in Equation 4. The LCDC system is designed so that the first term, which is the contribution due to major loss, dominates versus the second term, which is the contribution due to minor loss. This is done to maintain a linear relationship between  $H_{Total}$  and  $Q_C$ .

$$H_{Total} = \frac{128Q_C\nu L_{Tube}}{g\pi D_{Tube}^4} + \frac{8Q_C^2 K_e}{g\pi^2 D_{Tube}^4} \quad (4)$$

### Sizing the Float Valve Orifice in the Constant Head Tank

The maximum coagulant flow rate,  $Q_{Coag}$ , is  $7.7 \text{ mL/s}$  for a plant flow rate of  $32 \text{ L/s}$ , a maximum coagulant dose,  $C_{CoagMax}$ , of  $40 \text{ mg/L}$  and a stock coagulant concentration,  $C_{CoagStock}$ , of  $166.7 \text{ g/L}$ , as shown by Equation 5.

$$Q_{Coag} = \frac{Q_{Plant} C_{CoagMax}}{C_{CoagStock}} \quad (5)$$

The float valve diameter of 0.142 inches, or 0.36 centimeters, was sized through application of the orifice equation, where  $Q$  is the chemical flow rate, the Vena Contracta value,  $\Pi_{VC}$ , is 0.62,  $g$  is the gravitational constant, and the height difference between the water in the constant head tank and the water leaving the stock tank,  $\Delta h$ , is 30 centimeters, as shown by Equation 6.

$$d = 2\sqrt{\frac{2Q}{\pi\Pi_{VC}\sqrt{2g\Delta h}}} \quad (6)$$

### Sizing the Float in the Constant Head Tank Float Valve Assembly

One important goal for the LCDC team is to minimize the size of the constant head tank (CHT) so that it is easier to make height adjustments of the CHT during calibration. The float assembly in the CHT is comprised of a float, rod, and valve. With this current flow rate, the existing float is minimally submerged. Therefore, through application of a statics equation, we determined that we can use a smaller float that is more submerged, and therefore use a smaller CHT.

Since the coagulant flow pressure is only 0.43 pounds per square inch (2.96 kPa), the float only needs to withstand a flow rate of 8 mL/s, and the area of the orifice is 0.187 inches (4.75 millimeters), a large force is not required to close the valve. The force required, independent of the weight of the ball and rod, is about 0.1 Newtons. Through application of Equation 7, and using a static equation for torque as shown in Equation 9, we determined that the size of the float could be significantly reduced.

$$F_b = V (\%V_{submerged}) \gamma \quad (7)$$

Rearrangement of Equation 7 produces Equation 8:

$$\%V_{submerged} = \frac{F_b}{V} \gamma \quad (8)$$

$$\tau = r \times f \quad (9)$$

The previous float, a 4 inch by 5 inch (10.16 centimeter by 12.7 centimeter) ellipsoid float only needed to be submerged by approximately two percent. In contrast, a very small float, (a cylinder with a radius of 1 centimeter and a height of two centimeters) needs to be submerged by 89%. Therefore, a smaller float that has more submerged volume can be used in the CHT; a comparison is shown in Figure 1.

Based on our calculations, it should be possible to use a standard 5-gallon (19 liter) bucket, which is guaranteed to be available in all our deployment areas. This will help to further standardize our plant designs, and ensure that it is possible to create a unified set of instructions. Additionally, even the smallest bulb is likely to provide a sufficient force to close the orifice when full, as the force is so small.



*Figure 1: Comparison of Float Sizes in CHT*

## Previous Work

Past LCDC designs assumed that the length of the small diameter tube was sufficient to ensure that the major head losses dominated the system. These designs also assumed that the linear relationship between the chemical flow rate and the major head loss would be maintained, as shown in the Hagen-Poiseuille Equation (see Equation 1). However, during the Spring 2011 semester, the LCDC team observed quadratic tendencies in the relationship between head and chemical flow (see Spring 2011 Final Report Initial Laboratory Results section for an analysis of the experiments that produced these results). Minor head losses result from flow expansions through the system and are proportional to the square of the chemical flow rate. When the Spring 2011 LCDC team observed these results, they designed a method to model the magnitude of the minor head losses and sought to eliminate their sources.

The Summer 2011 LCDC team discovered that a large percentage of the minor losses originated from the curvature of the small diameter tube. To reduce this minor loss, the small diameter tube was straightened by using a PVC trough, which was done by moving the stock tank and CHT from being mounted on a frame to being placed at a further distance away. Another method developed to minimize minor losses, which originate from expansions and curves, was to use smaller barbed connectors than necessary for the inner diameter of the small diameter tubing used. This greatly reduced the minor losses throughout the system. The Fall 2011 team focused on eliminating minor losses in the system and further developing the calibration methods. The Spring 2012 team focused on the design of a triple doser to dose coagulant prior to flocculation, dose coagulant before the filter and dose disinfectant after the filter. However it has been since decided that dosing coagulant before the filter is unnecessary.

The Summer 2012 design included a two-sided lever arm, two dosing tubes, and a sleeker design that contains fewer minor losses and improved aesthetics. The Fall 2012 team devised a drop tube connection design to reduce leakage, added cross bracing to the lever arm assembly to reduce bending of the lever arms, devised a new calibration device to enable fine-tuned adjustments, had the lever arm anodized, added a modified weight, and had the label, scale and logo mechanically engraved on the lever arm. An assembly drawing created

in Google SketchUp showing all of the LCDC components and dimensioned drawings are shown in Figure 2 below. A video showing the flow of chemicals through the system can be viewed from the following link: [Linear Chemical Dose Controller Video](#).

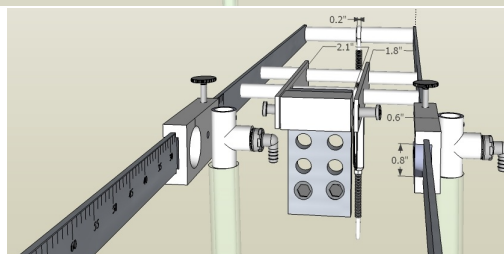
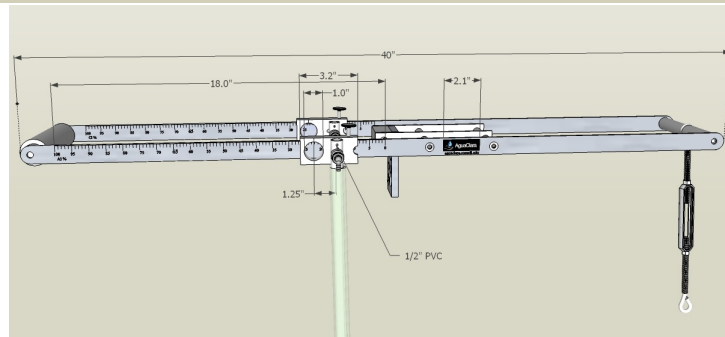
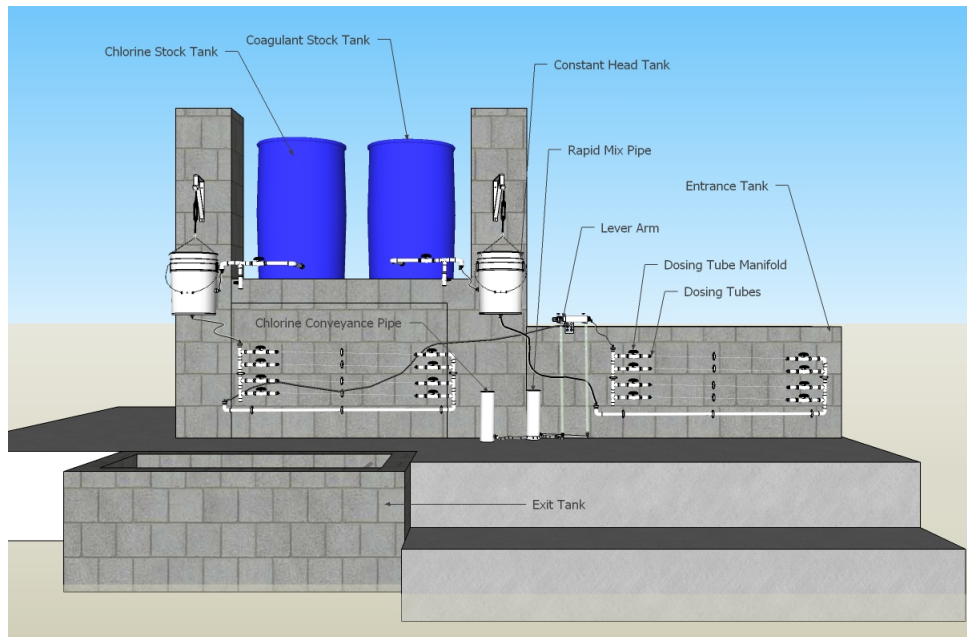

Figure 2: Linear Chemical Doser Controller Assembly Drawing (top) and dimensioned drawings of the lever arm (below). Note: When the lever arm is level and there is no flow through the system, the drop tube hole is aligned with the pivot point, and the center of the slider window is positioned 3.175 centimeters (1.250 inches) to the left of the pivot point, at zero on the scale

## Methods

### LCDC System Laboratory Setup

The main constraint for building the LCDC test system in the laboratory is the wall length in the lab (2.74 meters). Another constraint is using a readily available size of tubing, which is 1/8 inch, 0.3175 centimeters, for Honduras. The length constraint was adjusted in the AguaClara design files until a tube diameter of 1/8 inches resulted. Specifying a maximum length of 1.829 meters (6 feet), and other parameters shown below resulted in a dosing tube length of 1.308 meters.

- Target plant flow rate: 32 L/s
- Dosing tube diameter: 0.3175 centimeters (1/8 inches)
- Maximum coagulant dose: 40 mg/L
- Maximum coagulant flow rate: 8 mL/s
- Coagulant stock concentration: 166.7 g/L
- Dosing tube length: 1.308 meters (4.292 feet).

Figure 3 depicts the coagulant dosing tube, PVC manifold and PVC trough, with dimensions.

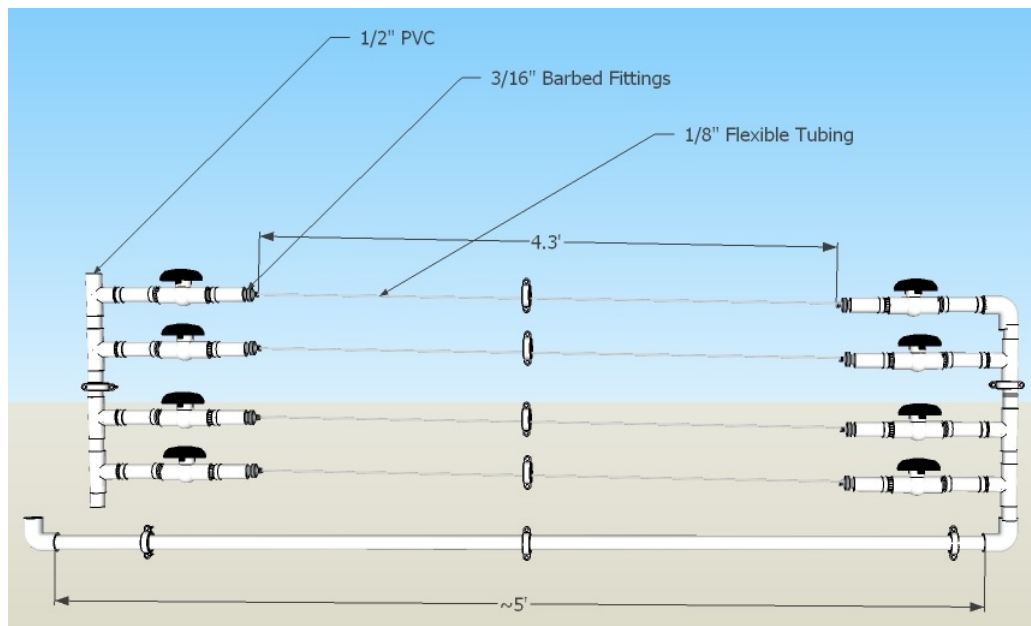

Figure 3: Coagulant Dosing Tube Dimensions



## LCDC Calibration

The LCDC can be calibrated as follows:

1. Add water to the entrance tank to ensure that the lever arm assembly adjusts properly to changes in flow. If it does not, then the entrance tank float is not sufficiently sensitive to changes in water height and will need to be modified.
2. Move the slider to the pivot point (zero flow).
3. As a starting point, measure the following heights, using the floor as a common reference:
  - (a) height of the water entering the drop tube.
  - (b) height of the inlet to the constant head tank (CHT) from the stock tank (i.e. the height of the float valve inlet on the CHT).
4. Adjust the height of the CHT by shortening the chain or adjusting the length of the CHT turnbuckle until the above-mentioned heights are approximately equal.
5. Set the height of the water in the entrance tank to zero to simulate a zero flow condition.
6. Run water through the system and ensure that air is not trapped in the system (push any air bubbles out by squeezing the tube exiting the constant head tank).
7. Re-adjust the height of the lever arm assembly until there is no flow through the system.
8. Level the lever arm assembly using the float chain for course adjustments and the turnbuckle for fine adjustments.
9. Repeat steps 5 through 8 until the lever arm assembly is level and flow rate is zero; this calibrates the lever arm assembly at zero flow.
10. Raise the height of the entrance tank water level to 20 centimeters above the current level (the maximum flow rate through the LFOM).
11. Move the slider to the 100 percent dosage setting (the maximum percent dosage).
12. Measure the flow rate using a graduated cylinder for one minute.
13. If the flow is lower than the desired maximum chemical flow, evacuate water from the system and cut the dosing tubes by a small amount.
14. Place water back into the system ensuring all air has been removed.
15. Repeat steps 11 through 13 until the maximum flow is reached and the system is fully calibrated.

## Manifold Design

We created a PVC manifold with ball valves to allow each dosing tube to be closed if needed; see Figure 4. The manifold can accommodate an extra dosing tube to allow the flow to be adjusted or to allow for maintenance.



Figure 4: PVC Manifold

## Drop Tube Design

The rigid PVC pipe in the drop tube assembly, as shown in Figure 5, has been designed for a length of 73 centimeters, which is the height difference between the top of the entrance tank wall and the sedimentation tank exit weir for the plant in San Nicolás. We are using a rigid PVC pipe to allow for a maximum free fall height at the above mentioned length to ensure that water is present at the bottom of the drop tube, which will improve chemical conveyance. A flexible tube, which can stretch and bend depending on the chemical dose, extends from the drop tube to the rapid mix unit.



Figure 5: Drop Tube

### **Laboratory Setup**

We created a laboratory setup to test for coagulant dosing and labeled all system components, as shown in Figure 6 below.



Figure 6: Laboratory Set-Up

### **Fabricating a New Chemical Dose Controller**

Hancock Precision provided a new quote to fabricate the lever arm assembly because the previous quote did not include the design modifications made during Fall 2012. The cost included the total price for various unit quantities. The more units that are constructed, the cheaper the unit cost because the initial setup of machinery is most costly but can be automated for subsequent units, see Table 1 for production costs. Therefore, after receiving approval from Monroe, we ordered two units, as shown in Figure 7 below, to be fabricated by Hancock Precision instead of by the Cornell Machine shop because it was determined to be more cost-efficient. If the unit were to have been fabricated by the Cornell Machine Shop, material costs alone are about \$100 per unit and anodizing is \$200 per unit, which would have only allowed for 5 hours of shop time per unit at \$40 per hour. One unit is in Honduras and the other is currently in the lab and expected to be deployed to India.



Figure 7: Fabricated Lever Arm

### **Anodization Issues**

We decided to use powder coating instead of anodization because powder coating is less vulnerable to prolonged exposure to sunlight and to a corrosive environment. After talking with Hancock Precision and doing research online, we found that the main reason the anodized parts turned purple was a combination of low quality dye (dye with low lightfastness) and an improper seal causing the dye to leach out. There are different qualities of dyes available in the market. Dyes of lower quality tend to fade or turn purple or green if exposed to light for an extended period of time. Hancock Precision sent samples of an anodized coating and powder coating. We left both the samples in bleach for a full day and found out that the color of the anodized sample faded while the powder coat did not appear to have any damage. Additionally, use of powder coating will enable the stainless steel weight to be coated on the end of the lever arm, since anodization cannot be performed on stainless steel materials.

### **Adjustable Constant Head Tank Height**

We created an adjustable constant head tank similar to a hanging plant that can be adjusted by shortening the chain that it is suspended from or adjusting the turnbuckle, as shown in Figure 8.



Figure 8: Adjustable Constant Head Tank Design

### Production of the Doser

We have discussed the possibility of having the dose controller manufactured by AguaClara, LLC or produced locally in the host country. One option is to have several lever arm assemblies built at one time, to lower the unit cost, by a machine shop in the US such as Hancock Precision on behalf of AguaClara, LLC (a sample quote is shown below in Table 1). Another option is to take a prototype or detailed specification sheets to the host country and determine if the lever arm could be produced at a machine shop in the host country, which is largely dependent on the conditions of the host country. The remaining system components are universal enough that they could be found in the host country (buckets, chains, PVC fittings, etcetera). However, it needs to be emphasized that any fitting be comprised of materials resistant to chlorine, such as PVC or PVDF (polyvinylidene fluoride) and not nylon, polypropylene or stainless steel, to prevent rapid deterioration of equipment.

<i>Number of Units</i>	<i>Unit Cost</i>
<i>1</i>	<i>\$822.50</i>
<i>2</i>	<i>\$475</i>
<i>4</i>	<i>\$350</i>
<i>10</i>	<i>\$285</i>

Table 1: Unit Cost of Production

## Experimental Data

We tested the doser at the maximum plant flow rate and the maximum coagulant dose rate (100%), using both water and coagulant. We measured the flow rate by measuring the mass of the water and dividing by the time and density. For 14 data points, seen below in table 2, the flow rate ranged from 6.6 mL/s to 7.8 mL/s with an average of 7.2 mL/s, which is below the MathCad estimate of 7.7 mL/s. We also tested the flow using coagulant (Alum), and the density, which we measured by dividing a known volume by its mass, which was very close to that of tap water. The flow rate of the coagulant was an average of 7.7 ml/s, which can be seen in table 3. This is faster than the average flow with pure water, and within ten percent error of the MathCAD prediction.

Time (s)	Mass (g)	Dose (mL/s)	Number
5.36	35.432	6.61	1
5.34	35.378	6.63	2
5.16	35.29	6.84	3
4.63	36.052	7.80	4
4.9	36.002	7.35	5
4.8	36.201	7.54	6
4.85	36.675	7.56	7
5.09	36.453	7.16	8
5.12	35.93	7.02	9
5.03	36.472	7.07	10
4.86	35.716	7.35	11
4.88	35.746	7.33	12
4.85	35.301	7.28	13
5.12	35.337	6.90	14
69.99	501.985	<b>7.17</b>	<b>Average</b>

Table 2: Water

Time (s)	Mass (g)	Dose (mL/s)	Number
5.05	38.66	7.66	1
5.14	39.765	7.74	2
5.39	40.63	7.54	3
5.48	42.105	7.68	4
5.26	40.708	7.74	5
26.32	201.868	<b>7.67</b>	<b>Average</b>

Table 3: Coagulant

## Universal Lever Arm Label

We decided to use the periodic table symbols for the lever arm, rather than “Coagulant” and “Chlorine”, to make the labels universal. Since both of the coagulants currently in use at water treatment plants are aluminum based, the coagulant symbol would be “Al” while the Chlorine symbol would be “Cl”.

## Retrofits to Existing Plants

After speaking with Drew Hart, a current AguaClara volunteer in Honduras, it was suggested that retrofitting existing plants is not a priority since the plants already have functional units and the operators in these plants are already familiar with how the doser in these plants function. Therefore, we did not address this challenge this semester.

## Future Work

Future teams could set up the disinfectant system in the laboratory, in addition to the existing coagulant system, to test how the system functions concurrently and to determine if adjusting one side of the lever arm will cause error in the other chemical dose. Additionally, the Design Tool needs to be updated to reflect the current design.





## Appendix





### Parts List

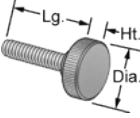

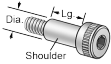
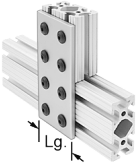

Table 4: Example list of components for the LCDC. This listing is for a LCDC designed for a  $32 \frac{L}{s}$  water treatment plant. Depending on the plant capacity, different quantities or sizes may be required.



Part Name (Quantity)	Picture	Description and Explanation	Vendor Link	Varies from Plant to Plant? (Yes or No)
Rectangular Bars—Un- polished Finish (2)		Lever arm: Multipurpose Aluminum (Alloy 6061) 1/8" Thick X 1" Width X 6' Length	<a href="http://www.mcmaster.com/#8975K17">http://www.mcmaster.com/#8975K17</a>	No







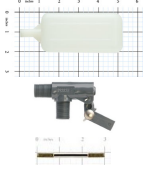

Rods—Unpolished Finish (1)		Lever end rod: Multipurpose Aluminum (Alloy 6061) 1" Diameter, 3' Length	<a href="http://www.mcmaster.com/#8974K133">http://www.mcmaster.com/#8974K133</a>	No
Rectangular Bars—Unpolished Finish (1)		Lever arm slider: Multipurpose Aluminum (Alloy 6061) 3/4" Thick, 1-1/2" Width, 1' Length	<a href="http://www.mcmaster.com/#8975K451">http://www.mcmaster.com/#8975K451</a>	No
Rectangular Bars—Unpolished Finish (1)		Lever spacer block: Multipurpose Aluminum (Alloy 6061) 1" Square, 1' Length	<a href="http://www.mcmaster.com/#9008K141">http://www.mcmaster.com/#9008K141</a>	No
Plastic-Head Thumb Screws (2)		Locks the sliders on the lever arm in place: Plastic-Head Thumb Screw Black Knurled Head, 10-32 Thread, 1" Length	<a href="http://www.mcmaster.com/#93015A208">http://www.mcmaster.com/#93015A208</a>	No
Aluminum Un-threaded Spacers (4)		Lever Arm Spacers: Aluminum Un-threaded Round Spacer 1/2" OD, 1-3/4" Length, 1/4" Screw Size	<a href="http://www.mcmaster.com/#92511A081">http://www.mcmaster.com/#92511A081</a>	No
Aluminum Unthreaded Spacers (2)		Lever arm cross bracing: Aluminum Unthreaded Round Spacer 1/2" OD, 2-1/2" Length, 1/4" Screw Size	<a href="http://www.mcmaster.com/#92510A459">http://www.mcmaster.com/#92510A459</a>	No



Steel Rod (1)		Used as the counterweight against the float, on the opposite end of the lever arm from where the entrance tank float is connected: 6" long total (0.5" on both ends are 1" diameter to accommodate the slider and the center 5" is 1-3/4" in diameter)	<a href="http://www.mcmaster.com/#8920K311">http://www.mcmaster.com/#8920K311</a>	No
Turnbuckle (1)		Calibration device: used to make fine tune adjustments to the height of the LFOM float and attached to the end rod of the lever arm.	<a href="http://www.mcmaster.com/#2998T51">http://www.mcmaster.com/#2998T51</a>	No
Entrance Tank Float (1)		LFOM float: Charlotte Pipe and Foundry Co. 6" PVC with hook screwed into lid	<a href="http://www.charlottepipe.com/Products/Assets/02C-PVC_List_Price/PVC-LD-111%20(11-29-12).pdf">http://www.charlottepipe.com/Products/Assets/02C-PVC_List_Price/PVC-LD-111%20(11-29-12).pdf</a>	No
Chain (3')		Used to attach the LFOM float to the turnbuckle on the lever arm assembly	<a href="http://www.mcmaster.com/#standard-chain/=mhbkde">http://www.mcmaster.com/#standard-chain/=mhbkde</a>	No
Float hook (1)		Used to attach the chain to the LFOM float	<a href="http://www.mcmaster.com/#rigging-hooks/=mhblcy">http://www.mcmaster.com/#rigging-hooks/=mhblcy</a>	No

PVC Drop Tube (2)		The point of discharge from the LCDC into the water supply. 3/4" clear rigid PVC pipe	<a href="http://www.mcmaster.com/#standard-pvc-tubing/=mhblz7">http://www.mcmaster.com/#standard-pvc-tubing/=mhblz7</a>	Yes, varies with height of entrance tank in relation to the sediment tank weir
PVC Drop Tube Elbow (2)		Used to attach the tee in the drop tube assembly to the tubing from the manifold. 1/2" NPT x 3/8" Tube ID	<a href="http://www.usplastic.com/catalog/item.aspx?itemid=28021&amp;catid=551">http://www.usplastic.com/catalog/item.aspx?itemid=28021&amp;catid=551</a>	No
Shoulder Screws (2)		Used to allow the lever arm assembly to pivot along the mounting bracket	<a href="http://www.mcmaster.com/#shoulder-screws/=mhb4at">http://www.mcmaster.com/#shoulder-screws/=mhb4at</a>	No
Brackets and Braces for Aluminum T-Slotted Framing		Bracket to mount the lever arm to the outer entrance tank wall, and to set up a frame during laboratory testing: Aluminum Inch T-Slotted Framing System Extended Plate, Double, 8-Hole, for 1" Extrusion	<a href="http://www.mcmaster.com/#47065T174">http://www.mcmaster.com/#47065T174</a>	No
End-Feed Fasteners for Aluminum T-Slotted Framing		Screws and fasteners to connect brackets and braces to the framing.	<a href="http://www.mcmaster.com/#aluminum-t-slotted-framing-fasteners/=mhb7bj">http://www.mcmaster.com/#aluminum-t-slotted-framing-fasteners/=mhb7bj</a>	No

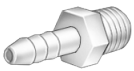
<p>Constant Head Tank (2)</p>		<p>Standard 5-gallon bucket with a hole drilled in the side to attach the float and a hole drilled in the bottom center for the through-wall barbed fitting. The cover prevents contamination of the chemical by particles in the air, but does not make the container air-tight.</p>	<p><a href="http://www.mcmaster.com/#4269T38">http://www.mcmaster.com/#4269T38</a></p>	<p>Yes; varies in relation to the size of the float required.</p>
<p>Constant Head Tank Float (2)</p>		<p>The float valve is attached to the side of the constant head tank, and keeps the water level constant inside the CHT: Kerick Float Ball PF45, 3/8 MIP inlet and outlet, 0.187 orifice. Float Ball and 3" metal rod with 1-4/20" thread</p>	<p><a href="http://184.173.229.127/~kerick/float-valves/ps0505xxx/">http://184.173.229.127/~kerick/float-valves/ps0505xxx/</a>  <a href="http://www.float-valve.com/items/float-balls/float-ball-pf224.html">http://www.float-valve.com/items/float-balls/float-ball-pf224.html</a>  <a href="http://www.float-valve.com/float-trods.html">http://www.float-valve.com/float-trods.html</a></p>	<p>Yes; the size of the orifice in the float valve depends can be determined by the orifice equation, which depends on the chemical flow rate.</p>
<p>Chemical-Resistant Clear PVC Tubing (20')</p>		<p>Conveys water from the drop tube to the manifold, the CHT to PVC, and the CHT to the stock tank: Clear PVC Tubing Chemical, 3/8" ID, 1/2" OD</p>	<p><a href="http://www.mcmaster.com/#chemical-resistant-clear-pvc-tubing/=mhbn64">http://www.mcmaster.com/#chemical-resistant-clear-pvc-tubing/=mhbn64</a></p>	<p>No</p>

<p>Standard-Wall/ Schedule 40 PVC Unthreaded Pipe (1)</p>		<p>Conveys water from the constant head tank to the dosing tubes: PVC Unthreaded Pipe 1/2 Pipe Size X 10' Length</p>	<p><a href="http://www.mcmaster.com/#standard-pvc-pipe/=mhbmvk">http://www.mcmaster.com/#standard-pvc-pipe/=mhbmvk</a></p>	<p>Yes; the approximate length depends on the length of the dosing tubes.</p>
<p>PVC Coupling</p>		<p>Used to shorten PVC length if needed: Couplings, Female Socket Ends</p>	<p><a href="http://www.mcmaster.com/#standard-pvc-pipe-couplings/=mhbgm7">http://www.mcmaster.com/#standard-pvc-pipe-couplings/=mhbgm7</a></p>	<p>No</p>
<p>PVC Pipe Fitting</p>		<p>Used to connect the tubing from the constant head tank to the first dosing tubes manifold: Thick-Wall PVC Threaded Pipe Fitting 3/8 Pipe Size, 90 Deg Elbow, Schedule 80</p>	<p><a href="http://www.mcmaster.com/#pvc-pipe-fittings/=mhbt ds">http://www.mcmaster.com/#pvc-pipe-fittings/=mhbt ds</a></p>	<p>No</p>
<p>PVC Ball Valve</p>		<p>Allows draining of accumulated sediment in PVC tubing, prior to entering dosing tubes: Low-Pressure PVC Ball Valve 1/2" NPT Female</p>	<p><a href="http://www.mcmaster.com/#pvc-ball-valves/=mhbb0s">http://www.mcmaster.com/#pvc-ball-valves/=mhbb0s</a></p>	<p>No</p>

<p>PVC Tee, Female Unthreaded Socket Ends (2)</p>		<p>Used in the drop tube assembly, also used to connect the manifold and ball valve to the PVC piping: Standard-Wall PVC Pipe Fitting 1/2 Pipe Size, Tee. **One tee needs a threaded middle connection**</p>	<p><a href="http://www.mcmaster.com/#standard-pvc-pipe-tees/=mhb3iw">http://www.mcmaster.com/#standard-pvc-pipe-tees/=mhb3iw</a></p>	<p>No</p>
<p>Barbed Tube Fitting (1)</p>		<p>Used to connect the CHT to the PVC assembly: Durable Nylon Multi-Barbed Tube Fitting Adapter for 3/8" Tube ID X 3/8" NPT Male Pipe. **Nylon fittings were used but chemical resistant fittings should be used in future designs**</p>	<p><a href="http://www.mcmaster.com/#pvdf-barbed-tube-fittings/=mhb1zh">http://www.mcmaster.com/#pvdf-barbed-tube-fittings/=mhb1zh</a></p>	<p>No</p>
<p>Chemical-Resistant Clear PVC Tubing (20')</p>		<p>Dosing Tubes: Clear PVC Tubing Chemical, 3/16" ID, 1/4" OD, 1/32" Wall Thickness</p>	<p><a href="http://www.amazon.com/Tygon-R-3603-Laboratory-Tubing-Length/dp/B000FMYVSK">http://www.amazon.com/Tygon-R-3603-Laboratory-Tubing-Length/dp/B000FMYVSK</a></p>	<p>Yes; based on the required chemical flow rate.</p>

<p>Adapters, Tube to Male Threaded Pipe (3)</p>		<p>Connects the tubing from the stock tank to the CHT and the tubing from the CHT to the PVC piping: Moisture-Resistant Acetal Push-to-Connect Adapter for 1/2" Tube OD X 1/2" NPTF Male Pipe</p>	<p><a href="http://www.usplastic.com/catalog/item.aspx?itemid=30741&amp;catid=832">http://www.usplastic.com/catalog/item.aspx?itemid=30741&amp;catid=832</a></p>	<p>No</p>
<p>Barbed Fitting Push-to-Connect Insert (3)</p>		<p>Attaches flexible tubing to the Push-to-Connect Adapter, preventing leaks from directly connecting flexible tubing to the rigid adapter: 1/2" barbed fitting to 1/2" Push-to-Connect</p>	<p><a href="http://www.usplastic.com/catalog/item.aspx?itemid=75126&amp;catid=915">http://www.usplastic.com/catalog/item.aspx?itemid=75126&amp;catid=915</a></p>	<p>No</p>
<p>Adapters, Male Threaded End to Female Unthreaded Socket End (2)</p>		<p>Connects the manifold and the ball valve to the PVC piping: Standard-Wall White PVC Pipe Fitting 1/2 Pipe, Male Adapter, NPT Male X Socket Female</p>	<p><a href="http://www.mcmaster.com/#plastic-pipe-fittings/=mgpv9y">http://www.mcmaster.com/#plastic-pipe-fittings/=mgpv9y</a></p>	<p>No</p>

<p>Adapters, Hose-to- Threaded Male Pipe (6)</p>		<p>Connects the dosing tubes to the manifold: Nylon Push-on Hose Fitting Adapter for 1/4" Hose ID X 3/8" NPT Male Pipe. **Nylon fittings were used but chemical resistant fittings should be used in future designs**</p>	<p><a href="http://www.usplastic.com/catalog/item.aspx?itemid=33364&amp;catid=551">http://www.usplastic.com/catalog/item.aspx?itemid=33364&amp;catid=551</a></p>	<p>Yes; based on the required dosing tube size.</p>
------------------------------------------------------------------	-----------------------------------------------------------------------------------	-----------------------------------------------------------------------------------------------------------------------------------------------------------------------------------------------------------------------------------	------------------------------------------------------------------------------------------------------------------------------------------------------------------	-----------------------------------------------------