

Physical Processing Guidelines for Shelf-Ready Chinese Approval Materials

Last Revised 11/20/2012

NOTE: The following guidelines illustrate how materials should be processed physically. These guidelines should apply to most of the materials in the plan, EXCEPT materials of certain dimensions:

- If an item has a SPINE of ¼-inch (.6 cm) OR LESS in thickness, AND is greater than 25cm OR less than 13cm in height, please affix a Barcode (step 1) and write the Call Number in the book, but please DO NOT apply the security strips, stamp, or spine label to the item (steps 2, 3, and 4).
- If an item has a SPINE of GREATER than 1/4 inch (.6cm), then steps 1-4 should be performed, regardless of the height of the book.

1. Barcodes:

- All items must have a barcode affixed to the cover of an item when the spine of the book is on the LEFT side, whether it is the front or back cover. (Fig. 1.1, 1.2).
- The barcode should be placed approximately 1-2 cm (.5 inch) down from the top edge, and 1-2 cm (.5 inch) in from the right-hand edge of the cover.
- Barcodes should NOT be placed on dust jackets. Please remove the dust jacket first, and apply the barcode to the cover of the book (Fig. 1.3). Please replace the dust jacket after the barcode is applied.
- If the barcode will cover any printing in its recommended location, affix it as close to that location as possible without covering printed information, but some covering of print or images may be unavoidable (Fig. 1.4). Barcodes should NOT be placed at the top LEFT corner, which may interfere with the placement of the Call Number label for thin books (see Section 4e).
- Horizontal orientation of the barcode is preferable, but not mandatory.



Fig. 1.1

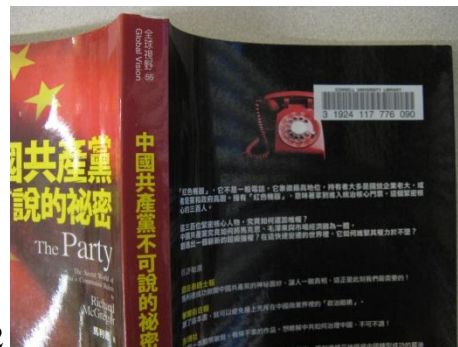

Fig. 1.2

(Fig. 1.1 and 1.2: Correct Barcode placement on cover, with spine on left side, regardless of whether it's the front or back cover).

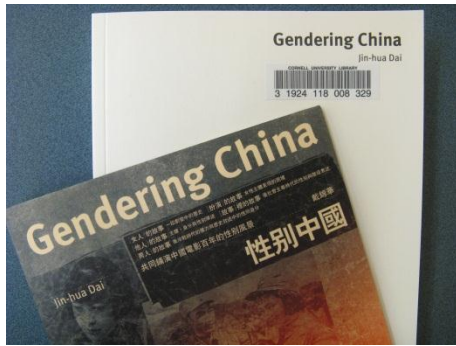

Fig. 1.3



Fig. 1.4

(Figs 1.3 and 1.4 show the barcode on the book underneath the dust jacket, and the barcode in the best available spot without covering printed information, respectively).

2. Security Strips:

- Security strips should be placed into every item.
- First, remove the shorter, darker green tab to expose the adhesive. (Fig. 2.1)
- Insert the exposed adhesive side between 2 pages of the book, as close to the spine as possible, and preferably near the back. Allow the adhesive to stick to the page, but make sure that no printed information is covered. (Fig. 2.2)
- After inserting the slip, remove the remaining green strip to expose the other adhesive side (Fig. 2.3), and the 2 pages will stick together over the strip (Fig.2.4). Make sure that the strip is inserted far enough toward the spine, so that all printing is still visible.



Fig. 2.1

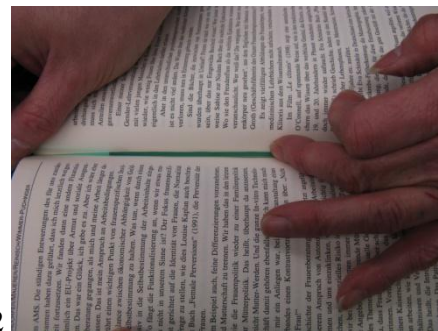

Fig. 2.2



Fig. 2.3



Fig. 2.4

NOTE: The metallic strips in the security tape have very sharp edges. Please handle with care to avoid accidental injury.

3. Stamping :

- a. The circular Cornell stamp should appear on the back of the title page, without covering any printed information. If the back of the title page has information that will not be readable with the stamp over it, the stamp can be put on the back of the Table of Contents page. Figure 3.2 shows the stamp near the bottom, but it can be placed anywhere on the back of the title page.



Fig. 3.1

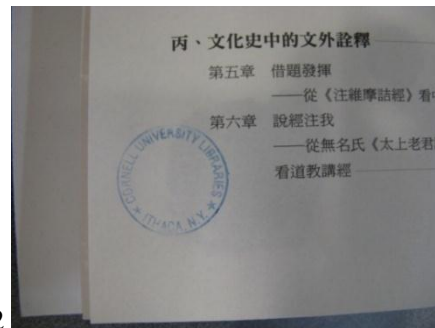

Fig. 3.2

(Figs. 3.1 and 3.2): Title Page with the Stamp on the back. Stamp should always be behind the Title Page, regardless of the direction of the print.

4. Call Numbers and Spine Labels:

- a. The Call Number of each book should be hand-written clearly in **pencil** inside the book, using the same vertical arrangement as the spine label (see below). For soft-cover books, it should be written on the back of the title page, using the best available space, but please allow a minimum of 1cm. from the top and side of the page, so the item can be trimmed along those edges.
- b. For Hardcover books, the Call Number should be written in the upper corner of the inside cover. If the paper is too dark, or if there is a map or image on the inside cover, the Call number can be written on the back of the title page, as with soft-cover books.
- c. Spine labels will display the Call number of each book, with the top part showing 'ASIA' for all items. The type should be arranged vertically, with the first letter/number combination separated in the first 2 lines. All decimals should appear at the BEGINNING of the appropriate line, and the date (if available) appears at the end, by itself.

- i. Example: If the Call number is PL961.7 .Y46 2010, the spine label will show:

ASIA
PL
961
.7
.Y46
2010

NOTE: Spine Labels should be printed in **BOLD**, using **Times New Roman** Font, Size 14.

- d. Spine labels will be affixed to the lower spines of each book. Some trimming of the label may be necessary, but the entire Call number must be legible. A small space between the bottom of the label and the bottom of the spine is also recommended, to ensure full visibility. (Fig. 4.1)

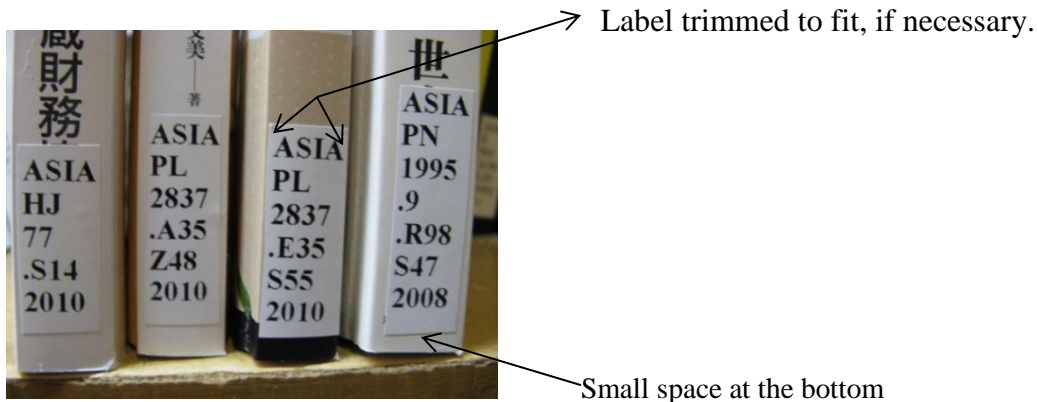

Fig. 4.1

- e. If the spine of the book is too narrow for a trimmed label (but still greater than ¼ inch, or .6cm), it must be put on the top left-hand corner of the cover **when the spine is pointing left, regardless of whether this is the front or back cover**. This rule applies **even if the label will cover up text on the cover, because the title can still be read on the spine**. When the book is shelved, the label should ALWAYS be on the right-hand side. Unlike stamps and barcodes, the placement of the label on items with narrow spines is always the same, and does NOT depend on how the item is printed:

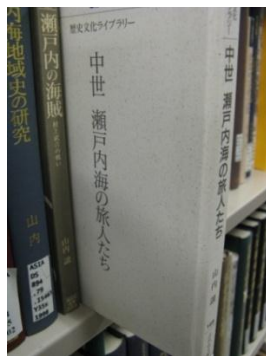

Fig. 4.2

(Front Cover)

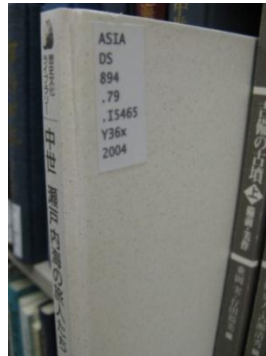

Fig 4.3

(Back Cover)

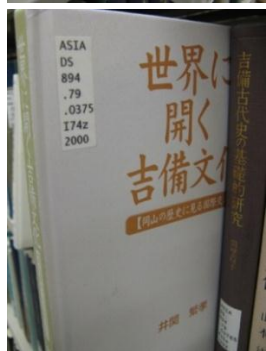

Fig. 4.4

(Front Cover)

(Figs 4.2-4.4: narrow items with the label properly placed on the right side, whether it is the front or back cover.)

f. **OVERSIZE Designations**—Items with dimensions between 25 cm and 30cm on the LONGER side (whether top-to-bottom or left-to-right*) should be designated Oversize with a plus symbol (+) at the end of the Call number. Similarly, items between 31cm and 49cm (Double Oversize) should have 2 plus symbols, (++), and items of more than 49cm (Triple Oversize) should have 3 plus symbols (+++) (Figs. 4.5-4.8)

i. The resulting Spine Labels for each of these cases will look like this:

1. ASIA	2. ASIA	3. ASIA
PN	PN	PN
56	56	56
T7	T7	T7
A85	A85	A85
2008	2008	2008
+	++	+++
(25-30cm)	(30-49cm)	(49+ cm)

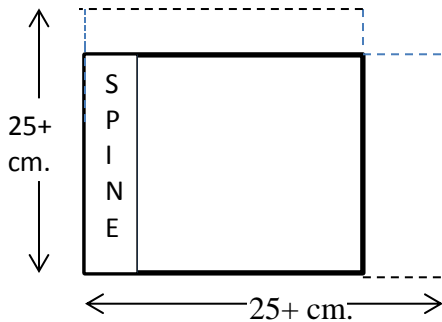

*The illustration at the left shows that items are designated Oversize whether they are TALLER than 25 cm OR WIDER than 25 cm.



Fig. 4.5

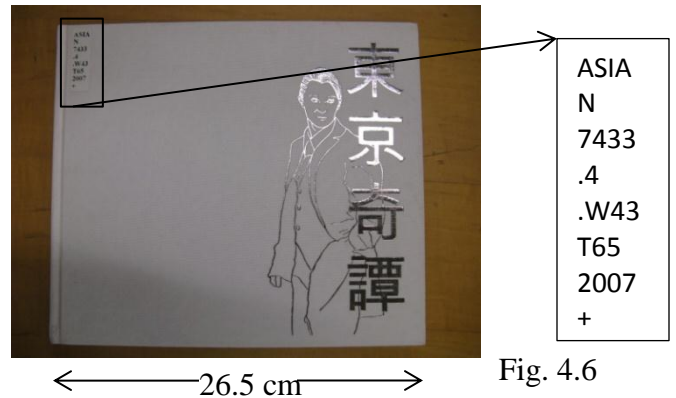

Fig. 4.6



Fig. 4.7 (Spine, 25-30 cm.)

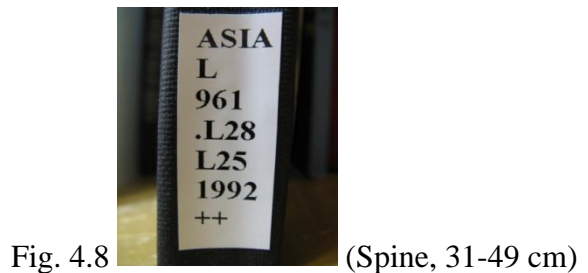

Fig. 4.8 (Spine, 31-49 cm)

NOTE: All measurements are to be rounded UP to the nearest whole number. An item of 25.1cm is given a measurement of 26 cm. in the MARC record.

- a. **Label Quality and Ink Adhesion-** The label stock must be compatible with hard resin thermal transfer ink ribbons. Wax ribbons or wax resin ribbons are not acceptable. It is critical that the ink adheres permanently to the call number label.

Examples of poorly printed and trimmed labels:

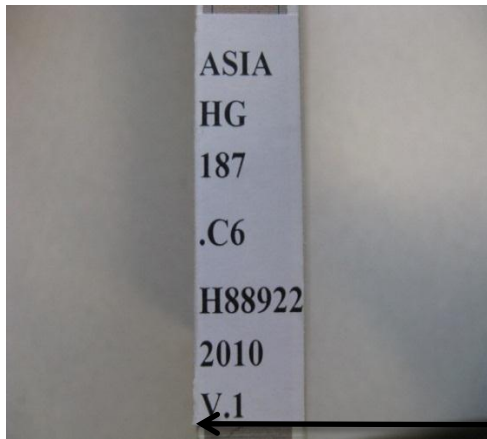
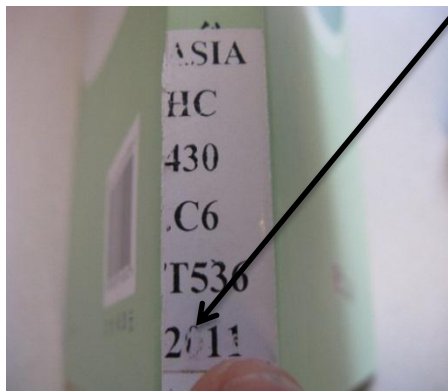
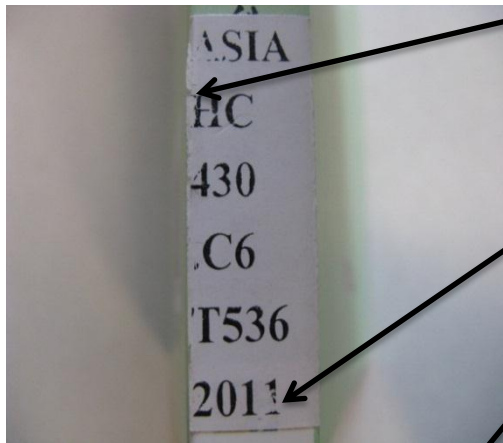

Fig. 1.1

Sides should be trimmed to fit better, or label should be put on the front cover of the book.

Ink comes off very easily, likely from the use of incorrect toner (see the “0” in “2011”).
*Our label Printer is a Zebra model TLP2844



5. Multi-volumes

- a. For works of more than 1 volume, all of the pieces will have a spine label showing the Call number, with a volume designation for each piece at the end. (v .1, v.2, etc.). A typical multi-volume Call number may look like this:

ASIA
PL
2623
D872
2010
v.1

(See also figs 5.1 - 5.2)

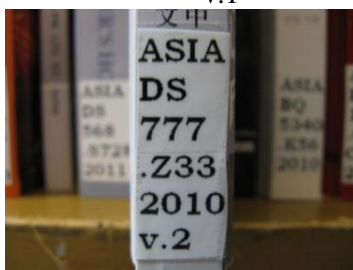

Fig 5.1

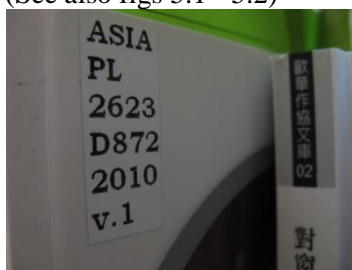

Fig 5.2

(Volume designations for different multi-volume work: 5.1 is on a book with a larger spine, 5.2 is a book with a narrow spine)

- b. If part of a multi-volume work is ALSO Oversized, the volume designation (“v.1”, “v.4”, etc.) will appear at the bottom of the label, BELOW the Oversize symbol (+, ++, or +++) (Fig. 5.3).



Fig. 5.3

(Multi-Vol. with Oversize Designation)

6. Hardcover Books With Accompanying Material (Maps, Pamphlets, Errata Slips, CDs/DVDs):

NOTE: Steps 6a – 6e. apply to **HARDCOVER BOOKS ONLY**. Please do not make pockets for paper materials or media discs on softcover materials. Errata slips can be glued into softcover books, however (see 6f.)

- a. For books that contain loose **Maps, Pamphlets, Plates, or other paper materials** (not attached to the book), each separate piece should be **stamped**, and the Call number of the book should be written on it.
- b. A pocket will be made, and glued to the inside back cover to hold the extra material. The pocket is made from an envelope made of heavy paper, used for documents. Size is ~ 15cm x 23cm for smaller ones, ~25.5cm x 33cm for larger. It is cut to fit the size of the book. The open side of the pocket should be on the **LEFT**, with the right side closed, so the materials will not fall out:



Fig. 6.1



Fig. 6.2

Figs 6.1-6.4: Pocket being cut from a (smaller) envelope, fitted to the size of the book, and glued to the inside back cover. In this example, accompanying material is 1 folded sheet, stamped, with the Call number (not visible).



Fig. 6.3



Fig. 6.4

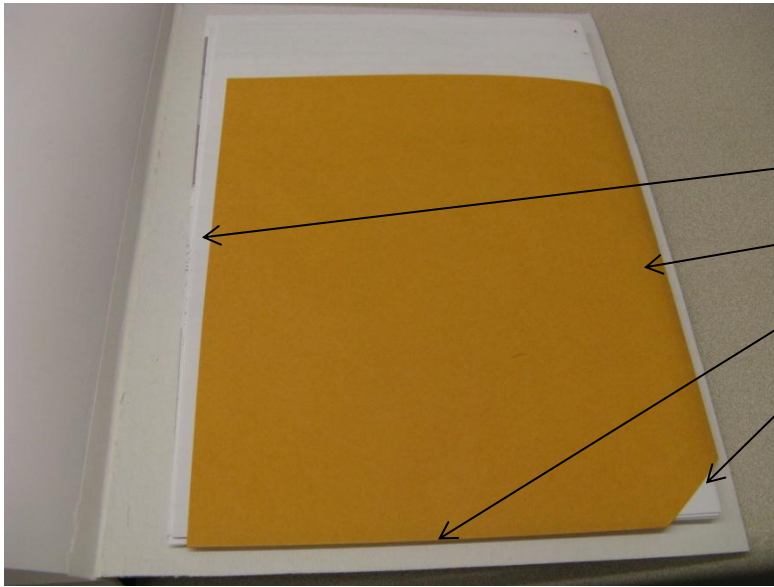

Fig. 6.5

Figure 6.5: Example of a book with several sheets of Accompanying Material (maps).

LEFT side is OPEN.

RIGHT side is CLOSED.

BOTTOM side is CLOSED

Lower right corner is cut, so maps will fit more snugly in the pocket (not essential, but helpful).

Maps have Call Number and Stamp (not visible). Envelope is larger size (~33x25.5cm).

- c. Occasionally, we will glue accompanying material into the book, instead of making a pocket for it. This is called “Tipping in”, and we use it most often for books with **Errata Slips** (a sheet that lists errors in the book, with corresponding page numbers), the edge of the slip should be glued in behind the title page (figs. 6.6-6.8), so that it stays in place, as its own “page”. (May be done with Softcover and Hardcover Books).

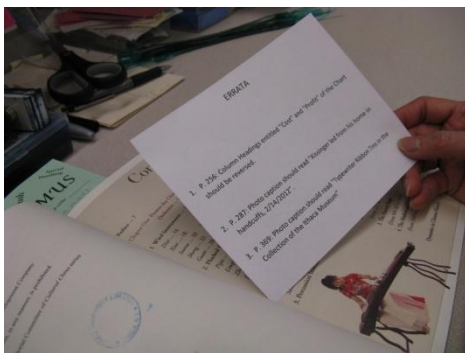

Fig. 6.6

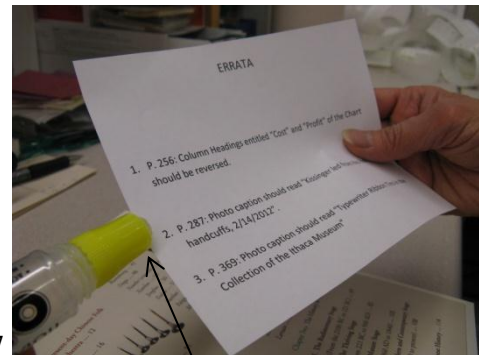

Fig 6.7

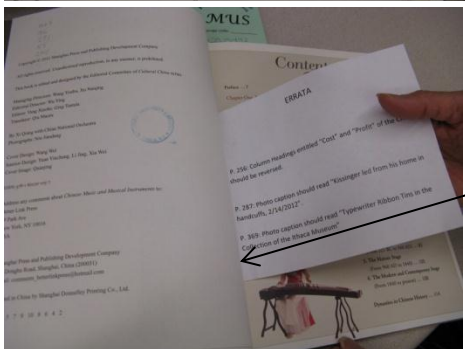
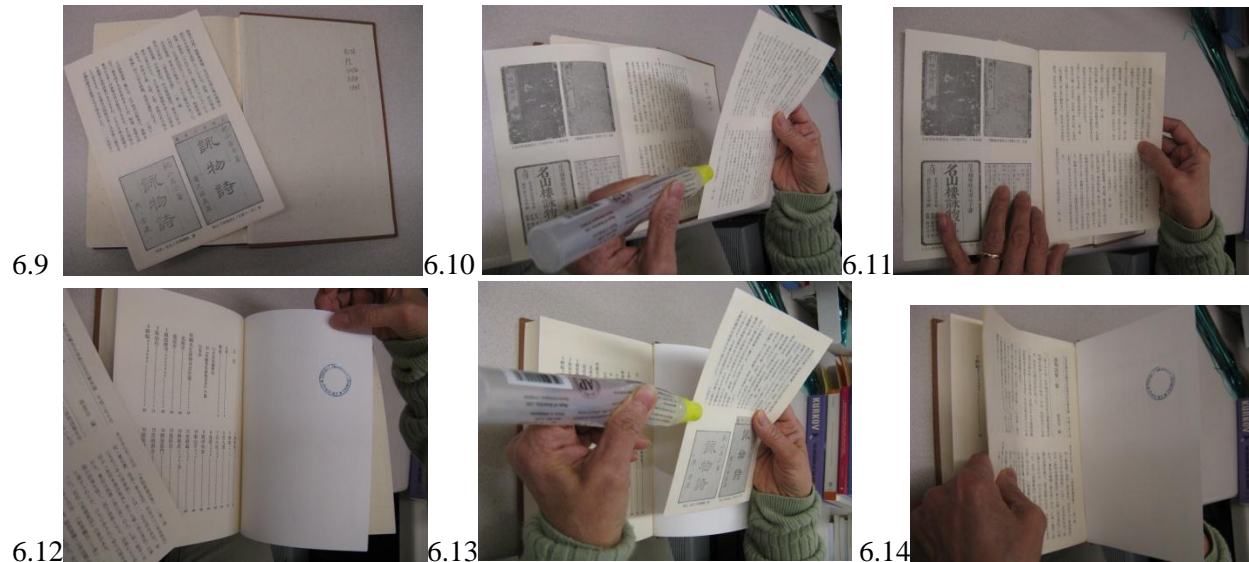

Fig. 6.8

ONLY THE EDGE OF THE SLIP Needs to be glued, so that the Errata slip will move like a separate page, but it still attached near the inside spine.

NOTE: Sometimes we will “tip in” items that are more than 1 page, as in these figures below (6.9-6.14). This was a small booklet of 8 pages, made of 2 folded sheets which we had to glue together first, and then tipped in behind the title page. **If you have questions on whether to make a pocket, or tip something in, please ask.**



- d. For HARDCOVER Books containing CDs, CD-ROMs, or DVDs, please write the Call number on the Disc in permanent marker (can be written vertically OR horizontally. See below), and cover it with a clear sticker that contains the metal security strips. (Fig. 6.15-6.17). Ours are made by 3M (called Tattletape DCD-2) **For CDs with very dark graphics, please use a silver/metallic or bright-colored permanent marker. We use Sharpie brand extra fine point pens, but other permanent ink pens will also work.**





6.17



6.18

- e. A pocket should be put on the inside back cover of the book, which will hold the CD (or DVD). A Copywrite Warning sticker should also be placed on the pocket (Fig. 6.19-6.22)



6.19

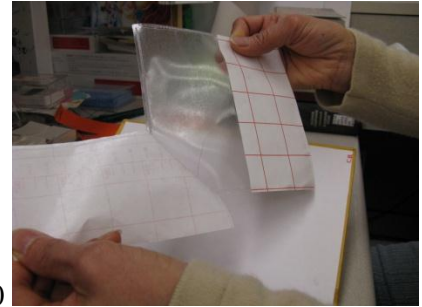

6.20



6.21

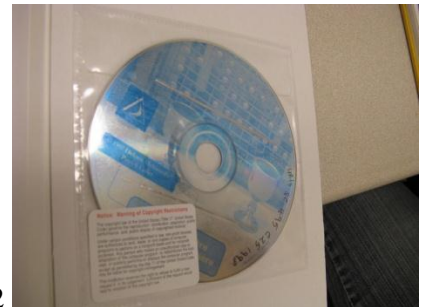

6.22

- e. If the CD or DVD has its own envelope or paper pocket, it should also be inserted into the pocket. Trim edges of insert if necessary. (Fig. 6.23-6.24, second photo shows CD WITHOUT security strip & Call number).



6.23

CD notes trimmed to fit pocket.
CD In front of notes, with sticker on the outside of pocket.



6.24

Other Examples (note Call numbers written horizontally or vertically. Whichever works best.):

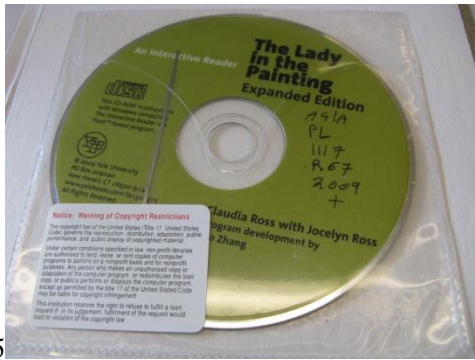

6.25

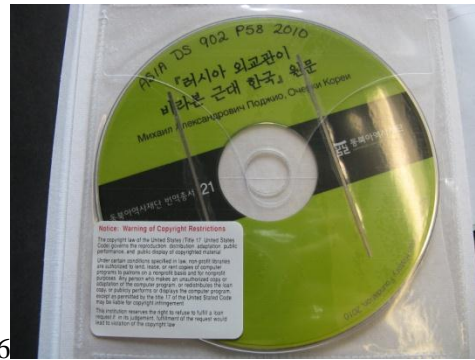

6.26

NOTE: Please **DO NOT** write or put security strips on **DOUBLE-SIDED** DVDs, OR CDs with no labels or stickers on them. **ASK CUL** for instructions for these, as regular procedures may damage them.

Example:



6.27

Double-Sided DVDs or CDs SHOULD not be labeled or marked with Call numbers, or they may not play properly. The Call Numbers should be written ONLY on the inside clear plastic center of the disc. Please ask for assistance if you encounter one, and we will provide additional instructions and photos.

If you have any questions, or would like more information about these procedures, please contact:

Susan Cobb
Physical Processing unit
110 Olin Library
Ithaca, New York 14853-5301
USA
t. 607.255.4005
f. 607.255.6110
e-mail: smc18@cornell.edu

OR

Pedro Arroyo
Acquisitions unit
110 Olin Library
Ithaca, New York 14853-5301
USA
t. 607.255.5764
f. 607.255.6110
e-mail: pca1@cornell.edu