



Shareable Local Name Authority Reference Model

Jing Wang
Johns Hopkins University Libraries

ELAG 2018
June 4-7, 2018



JOHNS HOPKINS
UNIVERSITY



IMLS Shareable
Authorities
Forum Pages Blog

SPACE SHORTCUTS

 File lists

PAGE TREE

- 2016 October 24-25 In-Person
- 2017 April 10-11 In-Person
 - Background Paper
 - File lists
 - Grant Outputs
 - Inventory of related work
 - Presentations
 - Project Participants
- Updates

 Space tools ▾

Pages



IMLS Shareable Authorities Forum Home

Created by Ann Lang, last modified by Jason Aaron Kovari on Apr 23, 2018

Cornell University Library, in partnership with the Library of Congress, OCLC, the Program for Cooperative Cataloging, the ORCID organization, the Coalition for Networked Information, the Social Networks and Archival Context Cooperative, the BIBFLOW project, Stanford University Library and Harvard Library will hold a national forum on issues concerning local name authorities. Name authority files provide unique identifiers and records for people to ensure consistency in creation of descriptive metadata. Libraries create local authorities to serve a variety of purposes, usually within an institutional context; but these authorities have significant potential for reuse at other cultural heritage organizations and beyond. The April 2015 IMLS National Digital Platform Forum report emphasized the importance of enabling technologies (e.g., interoperability via linked data) and radical collaborations in supporting the mission of the cultural heritage sector. Our forum aims to bring together stakeholders working on shared local authorities in order to develop a shared understanding of the key issues. One of the goals of the project is to articulate those issues in a white paper that can serve as the basis for future work.

White Paper: <http://hdl.handle.net/1813/56343>The [first in-person meeting](#) of the IMLS Shareable Authorities Forum took place at Cornell University in Ithaca, NY on October 24-25, 2016.The [second in-person meeting](#) of the IMLS Shareable Authorities Forum took place at the Library of Congress on April 10-11, 2017.This project is funded by the Institute for Museum and Library Services (IMLS) : <https://www.imls.gov/grants/awarded/lg-73-16-0040-16>

Project Documents

- [White Paper](#)
- [Reference Model \(Draft\)](#)
- [Project participants](#)
- [2017 April 10-11 In-Person Meeting](#)
 - [Meeting Agenda](#)
 - [Meeting Summary](#)

Project Updates

- [2016-07-31](#)
- [2016-09-19](#)
- [2016-10-15](#)
- [2016-12-05](#)



SPACE SHORTCUTS



PAGE TREE

- › 2016 October 24-25 In-Person
- › 2017 April 10-11 In-Person
 - Background Paper
 - File lists
 - **Grant Outputs**
 - Inventory of related work
 - Presentations
 - Project Participants
- › Updates



Grant Outputs

Created by Jason Aaron Kovari on Apr 23, 2018

National Strategy for Shareable Local Name Authorities National Forum : White Paper
: <http://hdl.handle.net/1813/56343>

Shareable Local Name Authority Reference Model (Draft)
: <http://hdl.handle.net/1813/56582>

No labels

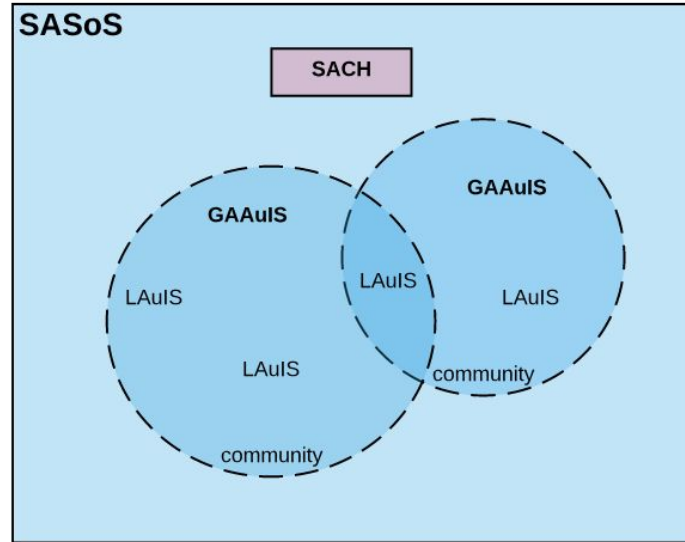

Note:

SASoS: Shareable Authority System of Systems

- **SACH:** Shareable Authority Clearing House
- **LAuIS:** Local Authority Information System
- **GAAuIS:** Global Aggregated Authority Information System

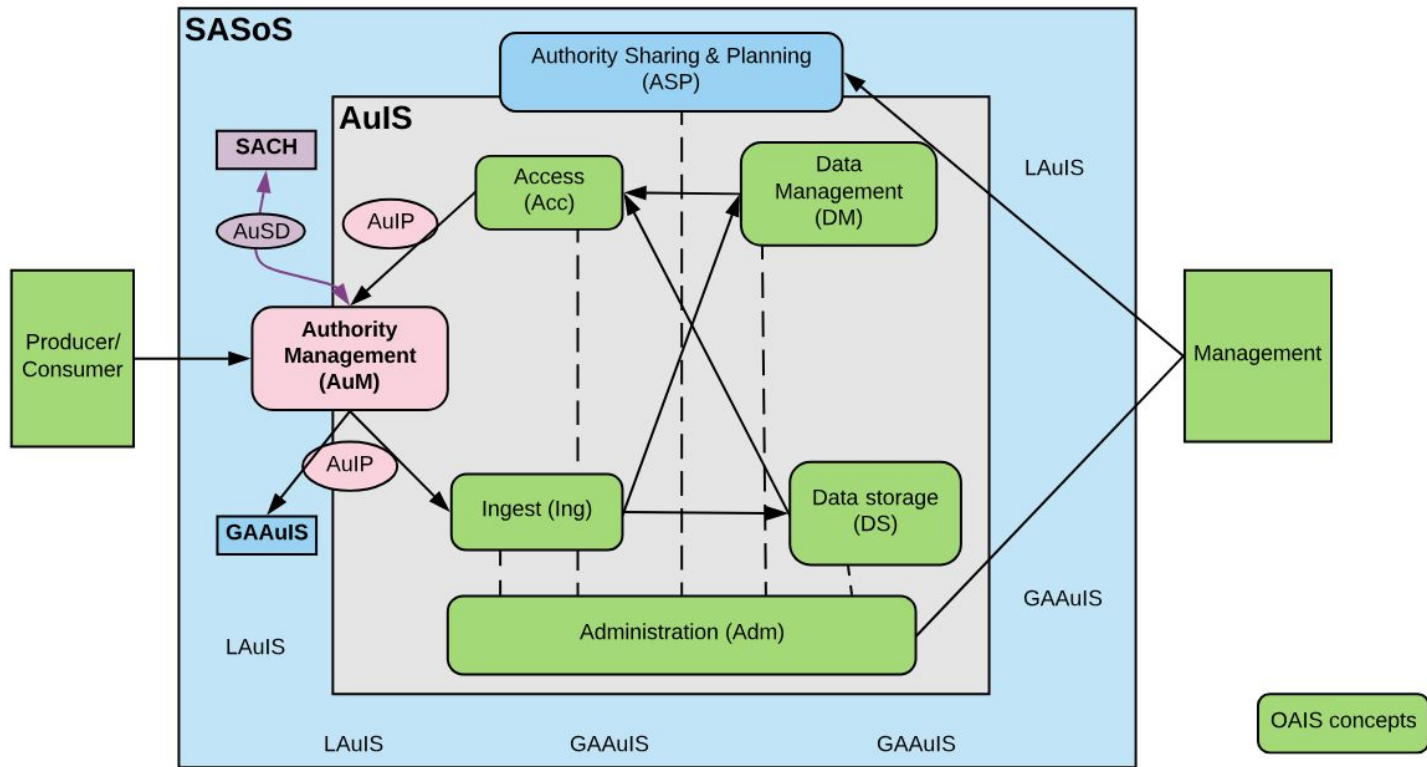

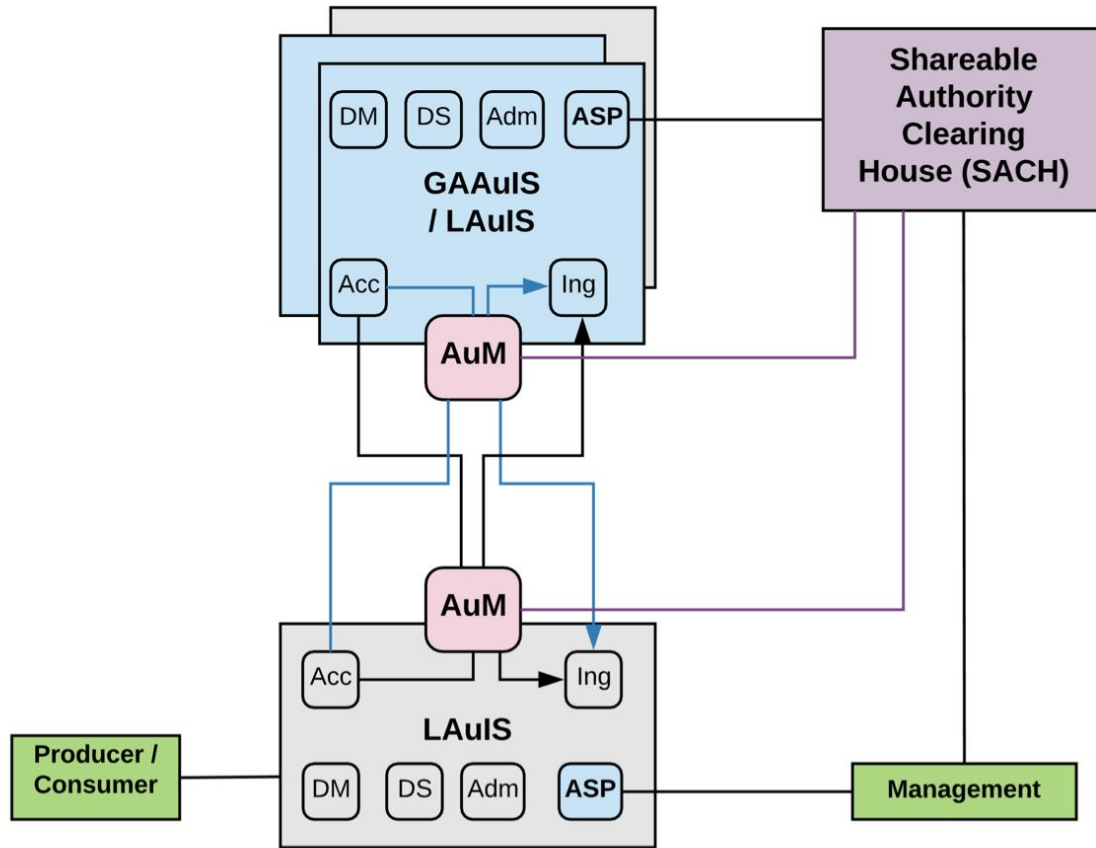

Note:
LAuIS: Local Authority Information System
GAAuIS: Global Aggregated Authority Information System
AuM: Authority Management
Ing: Ingest
Acc: Access
ASP: Authority Sharing & Planning
Adm: Administration
DS: Data Storage
DM: Data Management

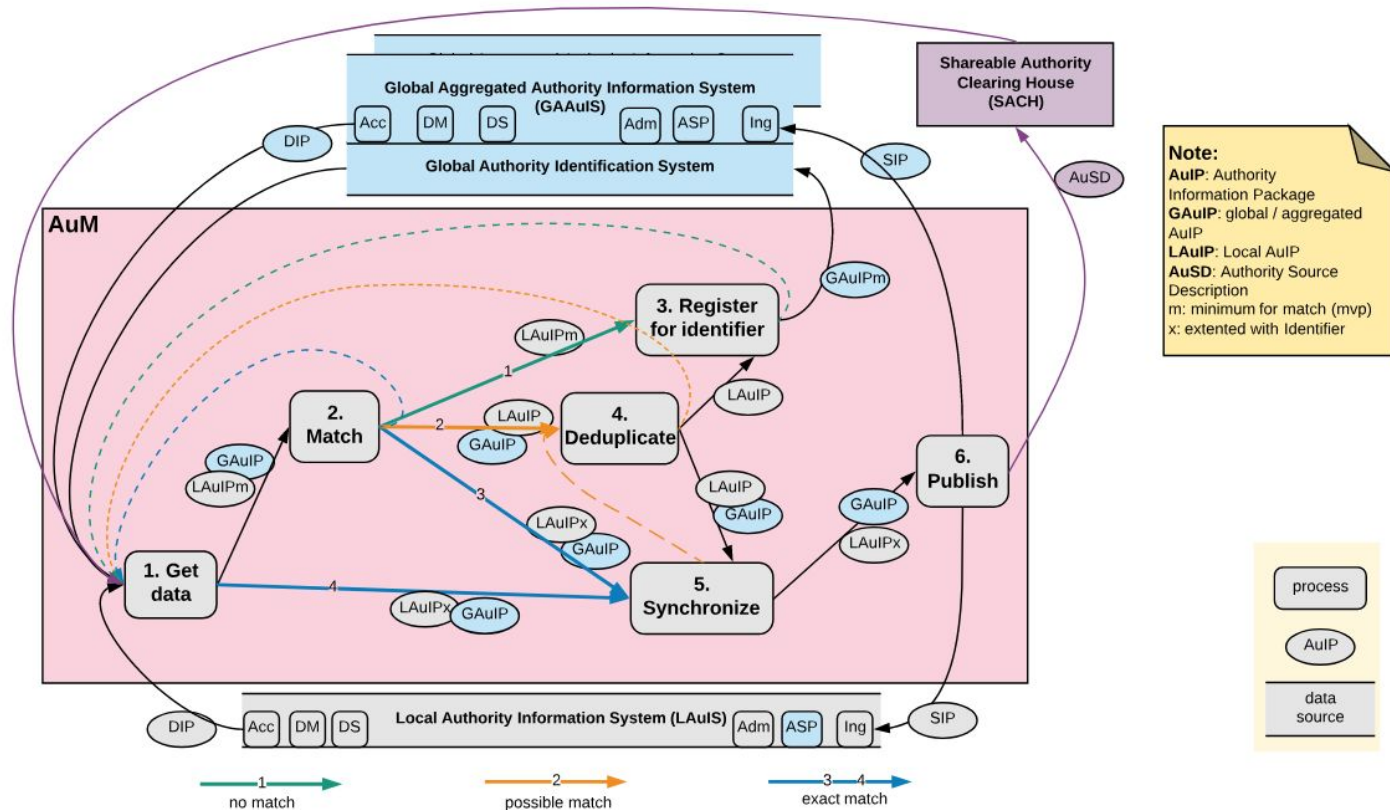

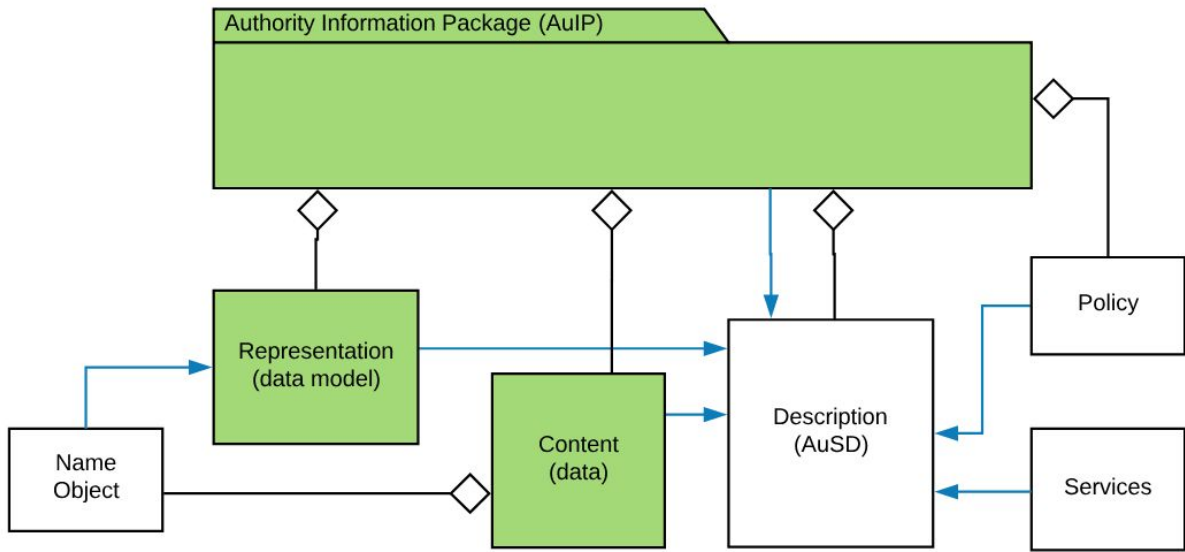

OAIS concepts

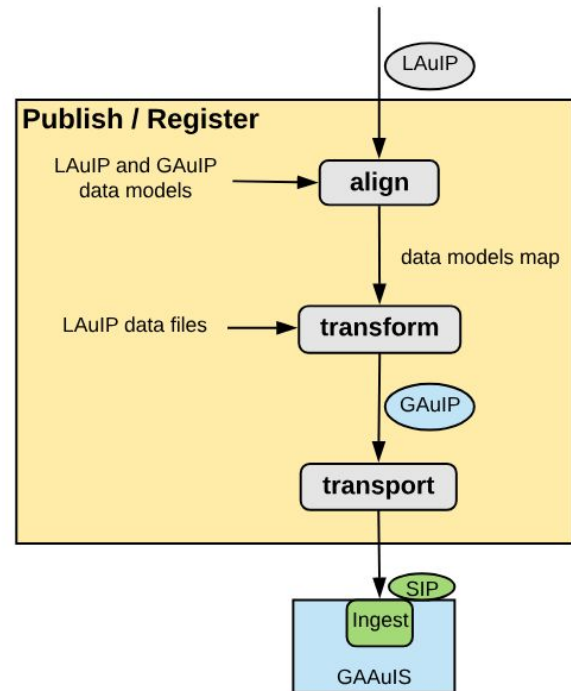
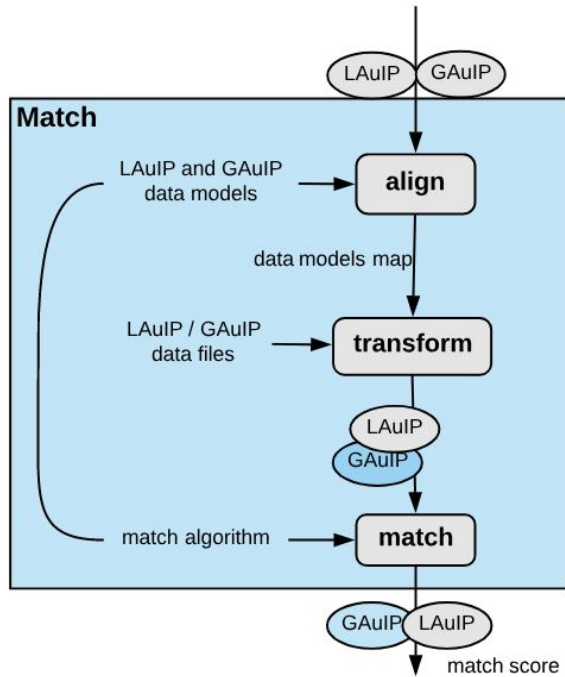



Reference

IMLS Shareable Local Authority Forum:

<https://confluence.cornell.edu/display/sharedauth/IMLS+Shareable+Authorities+Forum+Home>

SLNA Reference Model (draft)

<https://www.lucidchart.com/invitations/accept/d9b8cf83-0fe5-4e9c-9846-b499ea558aad>

OAIS Reference Model:

<https://public.ccsds.org/Pubs/650x0m2.pdf>



Questions?

Contact

jwang40@jhu.edu