

Humic Acid, Kaolin, Floc/Sed Model, Fall 2017

Ziwei(Vanessa) Qi, Ye Rin(Erin) Kim, Wen Tian Dai

December 10, 2017

Abstract

The Fall 2017 Humic Acid team was motivated to study the impact of the humic acid particles in water. Throughout the Fall 2017 semester, the team plans to explore the existence of optimal coagulant dosage that gives the lowest effluent turbidity at various humic acid concentrations. Then, the team seeks to set up a mathematical model that calculates the optimal coagulant dosage vs. humic acid concentration. A series of controlled experiments will be conducted with a computer software.

Introduction

Natural Organic Matter (NOM) is found in all ground and soil waters. There has been an increase in the amount of NOM in raw water supplies in areas. NOM in water can serve as nutrients for bacterias, viruses, and pathogens, which encourages their re-germination processes. Additionally, NOM produces by-products during the degradation process, which had previously been identified as carcinogenic. It then becomes imperative to remove NOM in water. Currently, there isn't a robust model that predicts how NOM behaves in water and thus, there are not effective treatment methods for NOM removal. Knowledge of this area is very limited, which consequently affects drinking water treatment significantly. The role of NOM in water might call for a need to increase coagulant doses.

AguaClara technology recently started including NOM in the water treatment model. NOM consists of several components and approximately 70% of dissolved organic carbon, a major component of NOM, is made up of humic acid materials. This is the main reason that humic acid molecules serve as an experimental model for dissolved NOM. Humic acid molecules are macromolecules and are usually 30-40 nm in diameter. It is hypothesized that these macromolecules stick on to, or potentially "coat", the coagulant particles. Due to this effect, the coagulant particles are hindered from forming flocs with the clay particles.

In Fall 2017, the Humic Acid, Kaolin, and Floc/Sed team was formed in response to the need for a robust model that removes NOM in water. A former graduate student, Yingda Du, conducted a research that indicated that the overall water treatment performance is positively correlated with the coagulant concentration at a certain humic acid concentration. Thus, the team researched on the effects of coagulants on humic acid and clay with a different set-up configuration and design of experiments. The ultimate goal of the Fall 2017 team is to design a flocculation model that successfully determines the most effective coagulant dosage for the influent stream with various HA concentrations. If possible, the team hopes to find the correlation between the optimal coagulant dosage and various HA concentrations. Consequently, the team's work will help AguaClara better understand what happens in real water treatment plants that process water with high concentration of dissolved NOM.

Literature Review

NOM negatively affects water quality by causing discoloration, taste and odor problems, promoting biological growth in distribution systems, increasing heavy metals, absorbed organic pollutants' concentration and coagulant doses. The increased particles in water consequently cause an increase in sludge volumes. (Matilainen et al., 2010) suggests that optimized coagulation is the major treatment option in decreasing NOM level. However, the nature of NOM has significant effects on the removal efficiency of coagulation. Additionally, the hydrophobic portion of NOM is generally removed more effectively with coagulation than does the hydrophilic portion. The effectiveness of flocculation on the removal of NOM also depends on several factors such as pH, temperature and coagulant type.

Soh et al. (2008) isolated dissolved NOM into four organic fractions based on their hydrophobic and hydrophilic properties (very hydrophobic acids, slightly hydrophobic acids, charged hydrophilics and neutral hydrophilics). This method was to determine the impact of alum coagulation on removal of these fractions in conventional water treatment. He found that the alum removed mostly hydrophobic and higher molecular weight components of NOM. This result further verified that the NOM removal efficiency is correlated with the properties of NOM. His study also revealed that a significant component of the NOM was found to be recalcitrant to this treatment even though alum coagulation removed a large proportion of NOM. This implied that NOM removal will not improve significantly at very high coagulant dosage.

With the aforementioned factors such as pH value that influence NOM removal efficiency, the team needs to design well-controlled experiments to avoid any unexpected variable affecting the experimental results. These studies also provide inspiration for experiments the team plans to conduct this semester, such as exploring the optimal coagulant dosage (the dosage which gives lowest effluent turbidity) at a certain humic acid concentration. Although some previous researches have discussed the existence of optimal coagulant dosage for removing NOM(or humic acid), there is few study concentrating on looking for this optimal coagulant dosage for different humic acid concentrations, which will be explored by the team this semester.

Previous Work

Yingda Du's thesis paper investigates the effects natural organic matter (NOM) has on flocculation. Particle size distribution of flocs and effluent turbidity are the two major criteria for determining the effectiveness of flocculation. These two parameters are affected by the concentration of NOM in the system. In order to model this system, humic acid, which is one of the major components of NOM, serves as the surrogate for NOM. Du hypothesized that variation in humic acid concentration will affect floc size distribution and effluent turbidity. In her thesis, she modeled the effects of humic acids in high turbidity water on flocculation.

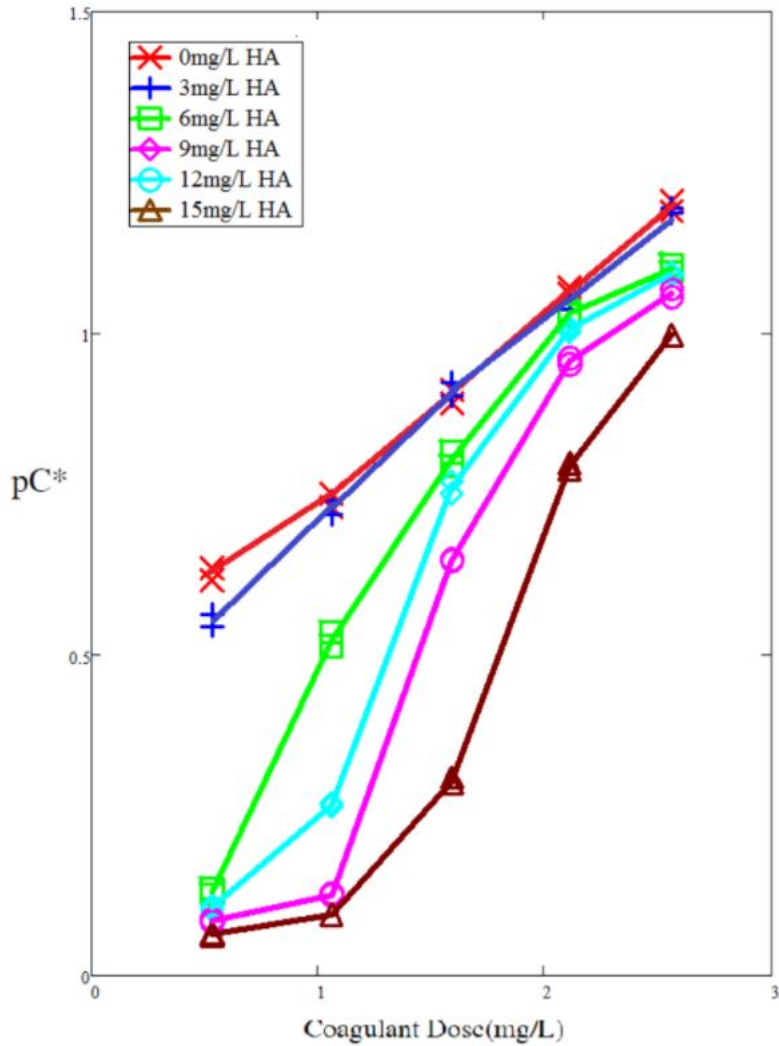

Figure 1: Yingda’s plot of turbidity at 50 NTU versus the coagulant dosage for various HA concentration.

For influent turbidity at 50 NTU with coagulant dosage ranging from 0.53mg/L to 2.65mg/L and humic acid concentration ranging from 0 to 15mg/L, a series of experiments from Yingda indicate that the coagulant dosage is positively correlated with turbidity removal and the presence of humic acid greatly increases the effluent turbidity. This was same for every experiment. An increase in coagulant dosage decreased the settled water turbidity.

Another finding from Yingda’s report is that the presence of humic acid increases the frequency of smaller particles after flocculation. As humic acid becomes coated with coagulant nano-particles, the attachment efficiency of collisions will decrease. Thus, humic acid can change the particle size distribution of the precipitated solids and larger particle formation is greatly inhibited by humic acid.

The Fall 2017 Humic Acid Team will investigate on improving the model that Yingda worked on in her thesis. Improvements of the flocculation model to predict the behavior of and the amount of humic acid in water will be made. As Yingda’s experiment has demonstrated that the coagulant dosage decreases effluent turbidity in the presence of humic acid, the team will test the optimal coagulant dosage (to achieve the minimum effluent turbidity) at various humic acid concentration. To standardize with other subteams in AguaClara, the humic acid team will use 100 NTU for influent water instead of 50 NTU.

Methods

Experimental Apparatus

To standardize with setup of other particle-removal subteams, 1-inch clear PVC pipe was chosen and fabricated so that the experimental apparatus has a 50 cm recirculator and 35 cm tube settler. The floc weir was 40 cm and the bent angle of tube settler was 60 degrees to the horizontal direction. The length of the tube settler was determined so that the capture velocity of .308 mm/s would be produced at the end of the reactor.



Figure 2: Standardized sedimentation tank

Four pumps were used to drive the tap water, clay water, humic acid solution and coagulant solution. Two turbidimeters were used to measure the turbidity of influent and effluent streams.

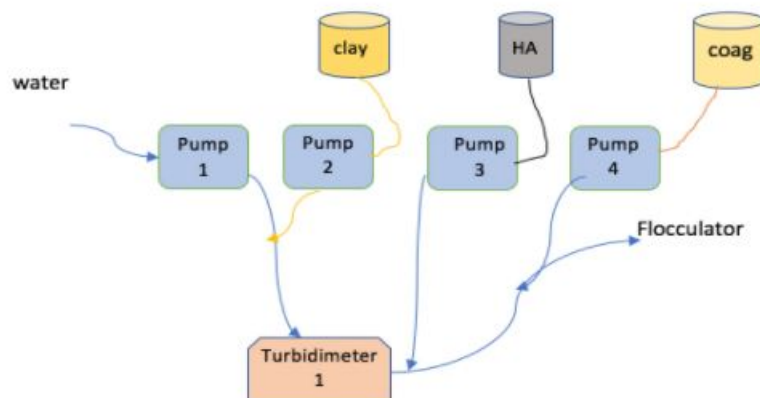

Figure 3: Schematic of experimental apparatus. The second turbidimeter is not shown.

Following the apparatus schematic, the team finished the experimental apparatus set-up as shown below.



Figure 4: Actual apparatus set up

The water pump speed was kept at 50RPM to achieve 2mm/s upflow velocity at current apparatus. This speed was measured manually because different pump might have minor difference. The clay pump was connected to the ProCoDa software to control the influent turbidity throughout the experiment at 100NTU. The set up of the ProCoDa was demonstrated at Manual section. The coagulant pump speed and humic acid pump speed was calculated in MathCad and controlled manually based on different experimental conditions.

The clay solution needs to be well-mixed before it enters the system. The team initially used a stir bar and a stirring plate to mix the solution. However, this set up did not produce a well-mixed solution consistently. The team decided to install the automatic stirrer in place of the original set up 4. However, the influent turbidity continued to drop because the clay mixture was not being pumped properly. After consulting with different advisors, the team decided to bring the pump down to the lab bench area to place the micro-tubing in a horizontal position. This was to ensure that the clay particles will not settle inside the micro-tube and cause blockage.

Procedure

First, the HA and coagulant solutions were formulated according to each experimental trial. The team varied the HA concentration from 5 mg/L to 15 mg/L in increments of 5 mg/L. For each HA concentration, the team varied coagulant concentration from 0.5 mg/L to 1.5 mg/L in increments of 0.5 mg/L. This design was set up to investigate the impact of HA concentration with different coagulant dosage.

The system was run with ProCoDa and the data were collected in a local drive. The effluent turbidity was recorded every 5 seconds to study the change in effluent turbidity as a function of time. The clay solution was continuously well-mixed with the mixer. The recorded data were plotted to show effluent turbidity in NTU as a function of time.

After sufficient data were gathered, a plot was constructed to show stabilized effluent turbidity as a function of coagulant dosage.

Results and Analysis

The first experiment was conducted with 5 mg/L of HA and 0.5 mg/L of coagulant. These concentration values were chosen to determine the effective coagulant dosage at the minimum HA concentration.

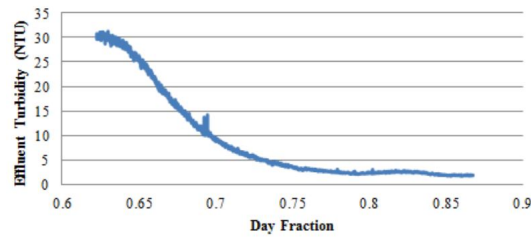

Figure 5: Effluent turbidity as a function of time with 5 mg/L of humic acid and 0.5 mg/L of coagulant. Day fraction corresponds to the fraction in a 24 hour period.

Figure 5 shows that effluent turbidity gradually decreases with time as expected. The lowest effluent turbidity from this experiment was 1.7106 NTU. The clay pump malfunctioned before reaching a day fraction value of 0.9. However, this did not matter as much because the effluent turbidity was expected to stay constant at a stabilized value around 1.7 - 2.0 NTU. In addition, a stable floc blanket formed at lowest effluent turbidity.

The team increased the coagulant dosage to 1.0 mg/L to determine if similar results would occur. During this experiment set, the team faced challenges associated with the clay pump. The clay pump malfunctioned before producing a reasonable data set. However, the team obtained a relatively reliable data set as displayed in Figure 6.

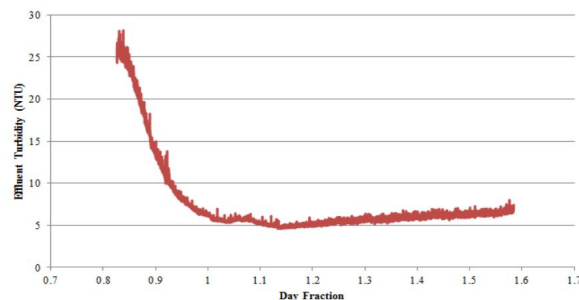

Figure 6: Effluent turbidity as a function of time with 5 mg/L of humic acid and 1.0 mg/L of coagulant. Day fraction corresponds to the fraction in a 24 hour period.

Figure 6 shows a similar behavior as did in Figure 5. The effluent turbidity gradually decreased with time and slowly increased after reaching the lowest effluent turbidity value. The lowest turbidity value was approximately 5 NTU. To ensure that this data set was accurate, the team conducted the same experiment again. The obtained results are shown in Figure 7 below.

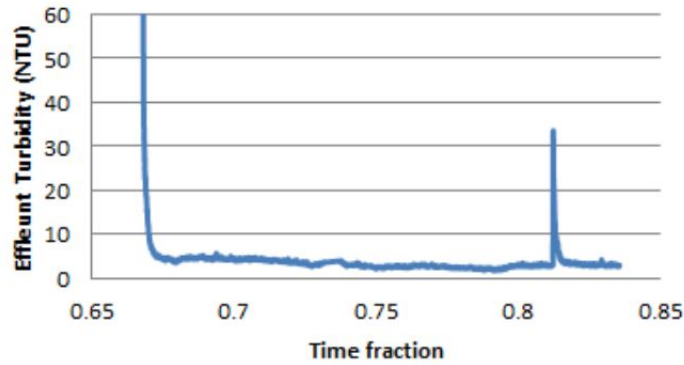

Figure 7: Effluent turbidity as a function of time with 5 mg/L of humic acid and 1.0 mg/L of coagulant. Day fraction corresponds to the fraction in a 24 hour period.

Figure 7 clearly shows that the lowest effluent turbidity was less than 5 NTU. This experimental trial yielded a lowest effluent turbidity value of 1.8902 NTU. The team ran other trials with the same HA and coagulant dosage and found similar results as Figure 7. Several experiments run at 5mg/L HA and 1mg/L coagulant condition has demonstrated similar or even worse result than experiment run at 5mg/L HA and 0.5mg/L. As expected, the effluent turbidity should drop down if the coagulant concentration increases since coagulation neutralizes charged clay particles inside recirculator. This counterintuitive result led the team to consider the influence of HA. To see the difference at a different coagulant concentration, the team decided to increase the coagulant concentration to 1.5 mg/L.

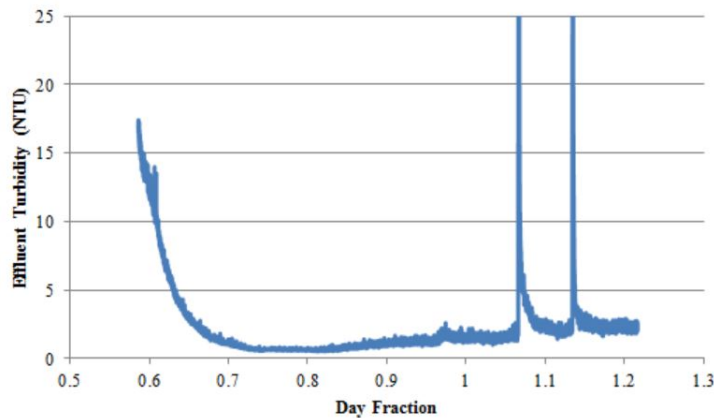

Figure 8: Effluent turbidity as a function of time with 5 mg/L of humic acid and 1.5 mg/L of coagulant. This set of experiment yielded a lowest effluent turbidity value of 0.56 NTU.

Figure 8 above clearly illustrates similar behaviors seen from previous experiments. However, this experiment yielded a lowest effluent turbidity of 0.56 NTU, the lowest value observed so far.

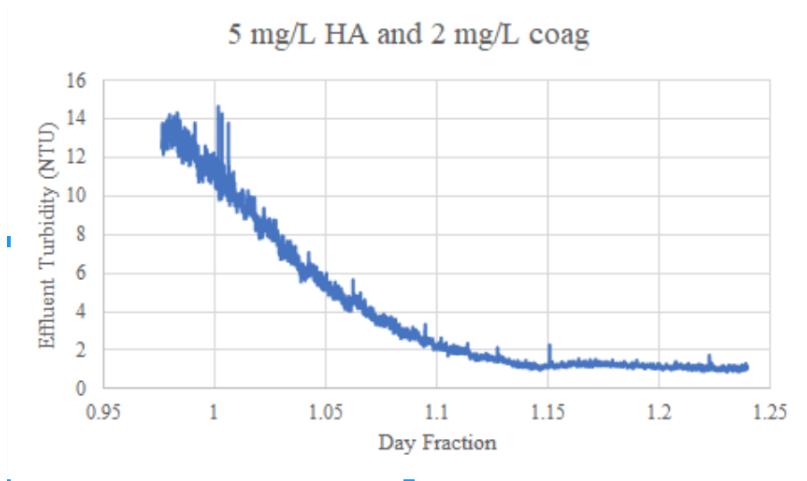

Figure 9: Effluent turbidity as a function of time with 5 mg/L of humic acid and 2.0 mg/L of coagulant. This set of experiment yielded a lowest effluent turbidity value of 0.9 NTU.

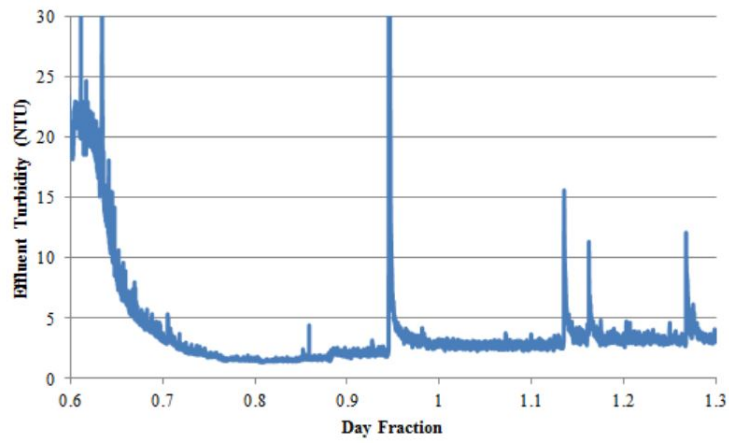

Figure 10: Effluent turbidity as a function of time with 5 mg/L of humic acid and 2.5 mg/L of coagulant. This set of experiment yielded a lowest effluent turbidity value of 1.36 NTU.

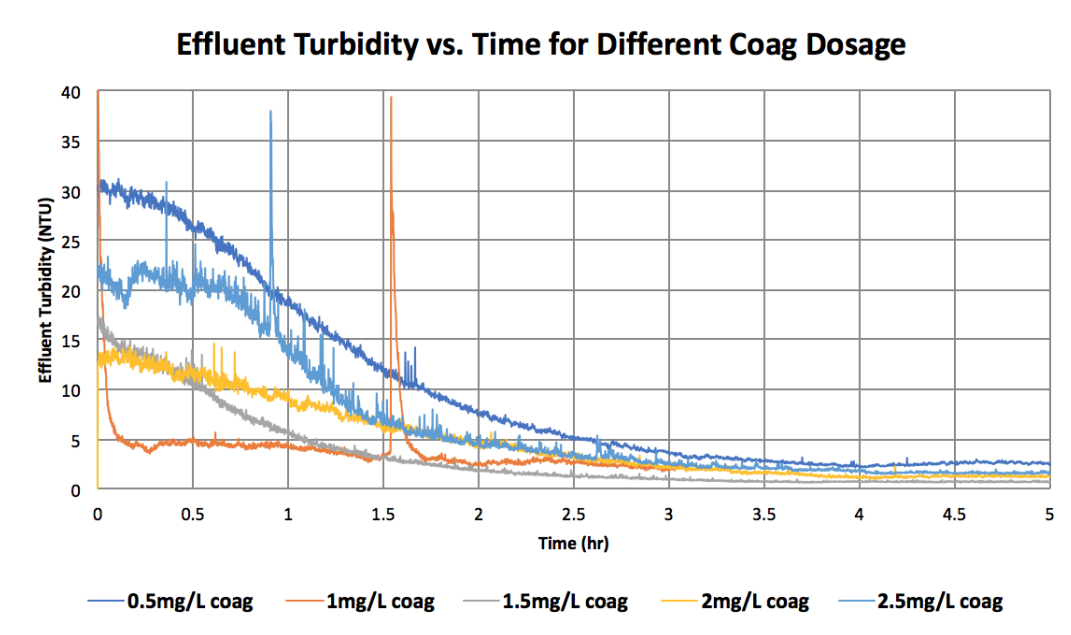

Figure 11: Effluent turbidity change vs time for different coagulant dosages ranging from 0.5mg/L to 2.5mg/L at 5mg/L HA



Figure 12: Floc blankets formed.

Figure 11 shows a sample of the floc blankets that were formed during these experiments. The floc blankets consisted of very small chunks of flocs and were relatively opaque.

Below is a table that shows the lowest achieved effluent turbidity at each coagulant dosage at 5 mg/L HA concentration.

Table 1: Lowest effluent turbidity achieved with each coagulant dosage.

HA Concentration	Coagulant Concentration	Lowest Effluent Turbidity
5 mg/L	0.5 mg/L	1.71 NTU
5 mg/L	1.0 mg/L	1.89 NTU
5 mg/L	1.5 mg/L	0.56 NTU
5 mg/L	2.0 mg/L	1.28 NTU
5 mg/L	2.5 mg/L	1.36 NTU

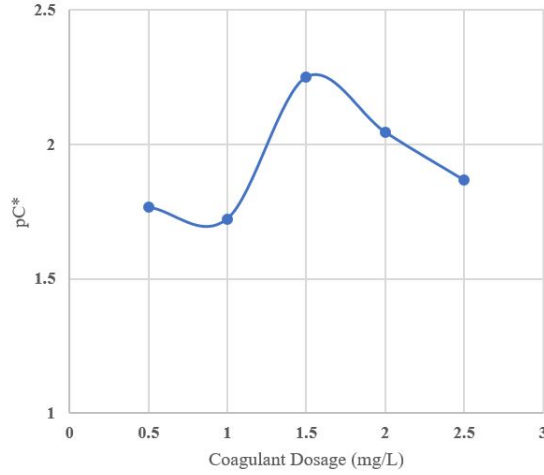

Figure 13: Turbidity removal efficiency as a function of coagulant dosage at 5 mg/L humic acid concentration.

Figure 12 displays a plot of turbidity removal efficiency as a function of coagulant dosage. Turbidity removal efficiency (pC^*) was defined as,

$$pC^* = -\text{Log}\left(\frac{\text{Effluent Turbidity}}{\text{Influent Turbidity}}\right). \quad (1)$$

Our results clearly show that there is a coagulant dosage range that yields the highest turbidity removal efficiency. This result is inconsistent with Yingda's finding. She argued that turbidity removal efficiency continues to rise as coagulant dosage increases. However, differences in the experimental apparatus and set-up might have caused this discrepancy.

Due to time constraints, the team only ran one set of experiment at 10 mg/L of HA concentration with 2 mg/L of coagulant. The accompanying plot is shown below.

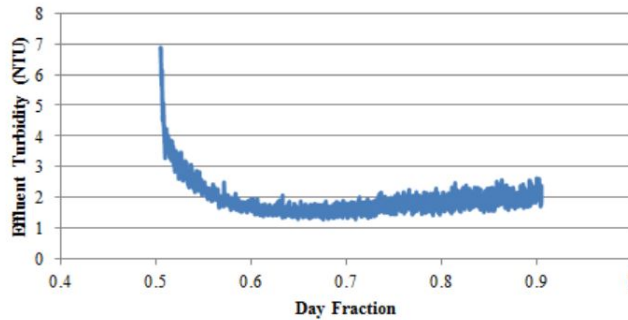

Figure 14: Effluent turbidity as a function of time at 10 mg/L of humic acid and 2 mg/L of coagulant.

The lowest effluent turbidity achieved was approximately 1.3 NTU. The team would need to conduct further experiment to investigate and identify a potential pattern that may provide a robust model that predicts the behaviors of HA during treatment with coagulant.

Conclusions

To explore the optimal coagulant dosage at different HA concentration, several trials of controlled experiments were conducted. The team varied coagulant dosage that ranged from 0.5 mg/L to 2.5 mg/L at each HA concentrations (5 mg/L, 10mg/L and 15mg/L). So far, the team found that at a low HA concentration, 5 mg/L, the effluent turbidity dropped down and then increased as the coagulant concentration increased. The optimal performance which gave the team the lowest effluent turbidity occurred at around 1.5mg/L. This result was consistent with the team's previous hypothesis because as former AguaClara particle-removal teams have found out, the increasing of coagulant concentration could decrease the optimal effluent turbidity, which is shown as the team increased the coagulant concentration from 0.5mg/L to 1.5mg/L. However, as humic acid particles "coat" on coagulant particles, the increasing in coagulant concentration will give higher optimal effluent turbidity, which is shown as the team increased the coagulant concentration from 1.5mg/L to 2.5mg/L.

One thing the team notices is that the difference between lowest effluent turbidities for different coagulant concentrations is small. Besides, the floc blankets formed at steady state for different coagulant concentrations are also pretty similar. However, due to the time constraint, the team does not run enough trials to further verify validity of the results

Future Work

Based on the experimental designs, the future team should continue to run the controlled experiments at different HA and coagulant concentrations. The team will need to finish conducting experiments at 10mg/L HA for different coagulant dosages and repeat for 15 mg/L of HA. Some additional concentrations out of the pre-determined range might be used due to special experimentation needs. Optimal coagulant dosages will be found for different HA concentrations and then compared with 5mg/L HA trial. After that, some parallel comparisons on lowest effluent turbidity could be done for certain coagulant dosage but different HA concentrations.

In addition, because the team found the pump speed controlled by ProCoDa was very slow if we used the pre-modeled equation. Therefore, the team calculated the pump speed and manually controlled the coagulant pump, which was relatively inefficient. After all the experiments are finished, the team might spend time figuring out why the pump speed is so slow.

References

- Matilainen, A. a., Vepsäläinen, M., and Sillanpää, M. (2010). Natural organic matter removal by coagulation during drinking water treatment: A review.
- Soh, Y. C., Roddick, F., and Leeuwen, J. v. (2008). The impact of alum coagulation on the character, biodegradability and disinfection by-product formation potential of reservoir natural organic matter (nom) fractionsa.

Semester Schedule

Task Map

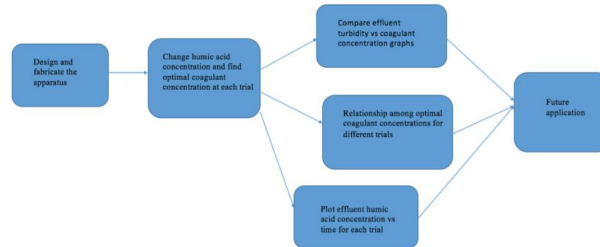

Figure 15: Humic Acid, Kaolin, and Floc/Sed model team's task map for Fall 2017.

Task List

1. ✓ Week 3 (9/11-9/15) Design and fabricate the apparatus: Meet with the other teams to design a standardized design apparatus and fabricate it.
2. ✓ Week 4 (9/18-9/22) Order any necessary parts and equipment. Continue to fabricate the apparatus.
3. ✓ Week 5 (9/25-9/29) Troubleshoot the apparatus. Change the stir bar and stirring plate with a stirrer with propeller.
4. ✓ Week 6 (10/2-10/6) Continue to work on troubleshooting apparatus.
5. ✓ Week 7 (10/11-10/13) Finish the apparatus set-up and calculations for the experiment. Prepare for the symposium.
6. ✓ Week 8 (10/16-10/20) Discuss feedback from symposium and make appropriate modifications on current apparatus/experiment methods. Start the experiment: Change HA concentration: Vary HA concentration (multiple increments until 15 mg/L). 5 mg/L of HA: experiment with coagulant concentration and find the effective coagulant dosage range.
7. ✓ Week 9 (10/23-10/27) Analyze the first set of data with 5 mg/L of HA and 0.5 mg/L of coagulant. Troubleshoot the clay pump. Run the next set of experiment with 5 mg/L of HA and 1 mg/L of coagulant.
8. ✓ Week 10 (10/30-11/3) Analyze data from week 9's experiment. Meet with Monroe to talk about the clay pump problem. Re-run the last experiment to determine if the collected data is accurate.
9. ✓ Week 11 (11/6-11/10) Re-run the experiment to get a better data set.
10. ✓ Week 12 (11/13-11/17) Analyze the data from last week. Troubleshoot clay pump. Run the next set of experiment.
11. ✓ Week 13 (11/21) Continue our work from last week.
12. ✓ Week 14 (11/27-12/1) Wrap up the final research report draft and start making the final presentation.

Report Proofreader: Vanessa Qi

Manual

Experimental Methods

1. Choose the experimental set-up by talking with other particle-removal subteams to decide. Construct the recirculator and flocculator.
2. Set up the ProCoda by determining what pumps and turbidimeters need to be controlled based on experimentation purposes.
3. Start experimentation running.
 - Collect data by ProCoda and upload to Google Drive
 - Adjust experimental designs based on results
 - Multiple trials should be conducted
 - Data analysis

Cleaning Procedure

- (a) Clean flocculator: insert a tiny piece of sponge into one end of flocculator and connect that end to tap water by a push connector. This should be done after every trial of experiment
- (b) Clean turbidimeter: take out the glass vial from the turbidimeter and wash the vial using soap and brush. Wipe the vial before putting it back to the turbidimeter. This should be done after every trial of experiment.

Experimental Checklist

- The ProCoda is connected and appropriately set up
- The stock solutions are enough.
- Every tubing is correctly connected.
- The influent turbidity is stabilized at 100 NTU.
- Floc blankets are formed in the recirculator.

ProCoDA Method File

Use this section to explain your method file (.pcm). This could be broken up into several components as shown below:

States

- OFF - Resting state of ProCoDA. All sensors, relays, and pumps are turned off.
- ON - Active state of ProCoDa. All sensors, relays, and pumps are turned on. Data are collected.

Set Points

Here, you should list the set points used in your method file and explain their use as well as how each was calculated.

- OFF : value = 0; type = constant
- ON : value = 1; type = constant
- unitID : value = 1; type = constant

- Turbidity Target : unit = NTU; value = 100; type = constant
- P : value = 300 m; type = constant
- i : value = 2.3; type = constant
- D : value = 0; type = constant
- Effluent Turbidimeter ID : value = 1; type = constant
- Effluent Turbidity : unit = NTU; type = variable; HF turbidimeter function
- Influent Turbidimeter ID : value = 2; type = constant
- Influent Turbidity : unit = NTU; type = variable; HF turbidimeter function
- Pump Control (clay) : type = variable; feedback control - PID setpoint no reset function; This set point controls the rpm of the clay pump to set the influent turbidity at 100 NTU.