

Ram Pump Research Report

Christine Curtis, Harrison Gill, Teresa Wong

May 10, 2012

Abstract

AguaClara plants are driven entirely by gravity. This makes it difficult to provide treated, running water in the plants to fill chemical stock tanks and to provide bathroom service. The Ram Pump sub-team was charged with designing and optimizing a pump to elevate a small amount of water in the plant. The pump works by transferring the momentum from a large amount of water falling a short distance into the potential energy to raise a small amount of water. Initial efforts were focused on designing and building a modular test pump to characterize how ram pumps function and how to optimize performance and ease of construction for specific sites. To accomplish this, we developed a MathCAD document to characterize the testing parameters that we anticipated would most affect the modular pump performance. From these parameters, we were able to collect data regarding cycle time, mass pumped per cycle, and average flow of the pump under various configurations. Future teams should explore better data acquisition methods to collect instantaneous velocity data within each cycle. Eventually, decisions regarding the design of the full-scale pump will be made based on experimentation with adjusting these parameters.

1 Review of Literature

1.1 Clemson University

Clemson University designed and built a demonstration ram pump. The documentation provided on their website includes designs, parts lists, operation instructions, and troubleshooting. Their design utilized 1-1/4" PVC pipe and fittings and was designed to run off of 4' of head and pump water to an elevation of 12'. The design also used commercially-available brass swing check valves. Since the site specifications for an AguaClara ram pump call for it to operate on approximately 50 cm of head using a 2" diameter drive pipe, the Clemson designs were not appropriate to build from as such. The spatial setup of the pump within the lab will not allow for 4' of head, let alone an elevation lift of 12'.

Although we could not use the Clemson pump design, we were able to make use of some of their design formulae and lessons learned from building their

pump. Their plans suggested that the volume of the air chamber be 20-50 times greater than the volume of water pumped per cycle. This is to provide a more continuous flow through the delivery pipe as well as to damp out the pressure shocks in the pump. Clemson's site also provided guidelines from the University of Georgia which gave the minimum and maximum lengths of drive pipes for ram pumps. Specifically they suggested that drive pipes should be a minimum of 150 times the diameter of the drive pipe and a maximum of 1000 times the diameter of the drive pipe. These numbers are apparently based on empirical data from the 1950's. The site also suggests that:

...if the inlet pipe is too long, the water hammer shock wave will travel farther, slowing down the pumping pulses of the ram. Also, in many instances there may actually be interference with the operation of the pump due to the length of travel of the shock wave.¹

Lastly, the Clemson design makes use of rubber inner tubes in the air chamber. These function to prevent the tank from becoming saturated with water, thereby reducing efficiency. The design also eliminates the need for a snifter valve to allow more air into the chamber.

1.2 Warwick University

The Development Technology Unit at Warwick University designed several ram pumps for use in developing countries in the late 1980s and early 1990s. The pumps were primarily intended for water distribution to small villages and for small-scale irrigation projects. The site includes pump plans, site considerations, and methods of construction. The site also has a good explanation on how ram pumps work, including a detailed section on the effects of hydraulic transients in the system.

According to the Warwick University technical documentation on ram pump installation, the shorter the drive pipe, the higher the frequency at which the pump will operate. Higher frequencies can lead to inefficiency in pumping and increased wear on components². The same paper also mentions that drive pipes should be as straight as possible and if gradual bends are necessary, they should be firmly anchored.

The site includes plans for a plastic-bodied pump which is designed to operate under conditions similar to those in the lab. Field experience with their design suggests that the pump has a two-year life expectancy³. The design makes use of a 4" drive pipe and a different valve configuration than we plan to use, but most of the components are made of the same materials and will

1

<http://www.clemson.edu/irrig/equip/ram.htm>

²<http://www2.warwick.ac.uk/fac/sci/eng/research/civil/crg/dtu/pubs/tr/lift/syst-des/broc.pdf>

³<http://www2.warwick.ac.uk/fac/sci/eng/research/civil/crg/dtu/pubs/tr/lift/rptr12/tr12.pdf>

experience similar forces and numbers of cycles, so a two-year life expectancy for our pump is not unreasonable.

The site also contains a discussion of the merits of tuning mechanisms on the waste valve of the pump. By making the valve tunable, the pump operation can be optimized for high flow or for efficient allocation of water. The problem with having a calibrated pump is that it must be periodically re-tuned, and if operators are inexperienced, the pump is likely to be left running inefficiently anyway. The same paper also discusses the advantages and disadvantages of using “contained air” in the air chamber. Pros include the elimination of leaks in the system, the elimination of the snifter valve, and the ability to operate the pump underwater. Cons include fatigue failure of the air bladders, loss of air through the bladders, and a reduction of volume during the initial cycles of the pump⁴.

1.3 Design of Homologous Ram Pumps

Professor Brian Young of the Papua New Guinea University of Technology has developed a generic mathematical approach applicable to ram pumps of all sizes. All ram pumps experience three stages of operation: acceleration, pumping, and deceleration. In the acceleration phase, the waste valve is open while the high pressure valve is closed (see Figure 2). As water flows through the open wasting valve, it accelerates until critical velocity is reached. At critical velocity, the wasting valve slams shut, overcoming the hydrodynamic forces keeping the valve open. The closed wasting valve induces a water hammer traveling at the speed of sound along the drive pipe, thereby opening the high pressure valve. As water fills the air chamber, pressure builds to push water out of the chamber and up the high pressure line. This stage, called the pumping stage, will continue until the available pressure from the water hammer decreases below the minimum opening pressure of the high pressure valve. When the high pressure valve closes, flow reverses and opens the wasting valve either through suction caused by the flow reversal or simply by the force of gravity. It should be noted that Young refers to the deceleration stage as the recoil stage. The waste valve and high pressure valve are also referred to respectively as the impulse valve and delivery valve.

Optimum ram pump operation assumes no deceleration stage. The mathematical analysis developed by Young assumes zero deceleration and examines pump operation caused by the shock wave, resulting in a step-wise decrease in velocity during the pumping stage as shown in Figure 1 corresponding to multiple pressure pulses occurring during each cycle. It is also assumed that the available delivery head is significantly smaller than the maximum delivery head. Furthermore, our design and calculations were based on a transient analysis. Despite these differences and the questionable validity of the drive pipe velocity model, several of Young’s findings were applicable to our design.

Firstly, the smallest working pump to be tested had a diameter of 20 to 25

⁴<http://www2.warwick.ac.uk/fac/sci/eng/research/civil/crg/dtu/pubs/tr/lift/rptr13/tr13.pdf>

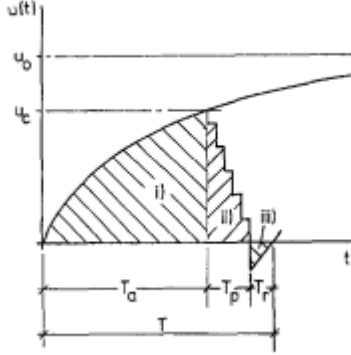

Figure 1: Young's drive pipe velocity vs. time diagram.

mm. The minimum operating drive pipe length was 5 m. Since our drive pipe is 2" in diameter, we anticipate a drive pipe length of 10 m, if not more.

Secondly, Young analyzed the hydraulic transients of the pump using dimensionless ratios. It was shown that the source flow rate to the critical flow rate at waste valve closure (i.e. $\frac{Q_{source}}{Q_{critical}}$) remains constant regardless of pump size. Also, given a specific pump size and wasting valve, the amount of water delivered is dependent only on the ratio of delivery head to supply head (i.e. $\frac{h_{delivery}}{H_{supply}}$). Moreover, the ratio of the length of the drive pipe to the supply head (i.e. $\frac{L}{H}$) is the most significant design criterion, determining the beat frequency and cycle time. Cycle time is independent of the amount of water delivered or wasted.

1.4 Relationship between the Basic Geometric Form and Hydrodynamic Characteristic of Water Hammer Pump (Saito et al.)⁵

The authors of this study evaluated ram pump performance in terms of pump head and flow rate, an evaluation similar to our intended approach. They examined the hydrodynamic characteristics of the pump by varying the drive and delivery pipe diameters, the form and capacity of the air chamber, and the angle of the drive pipe.

Their pump configuration was very similar to ours in that they constructed a modular pump with pipe reducers to vary the diameter of the pipes and adapters for swapping out different air chambers. In addition, the layout of their pump was identical to our design, with a tee diverting flow between the waste line and the high pressure line and the latter containing a gravity-powered valve. The

⁵Saito, Sumio et al. "Relationship between the Basic Geometric Form and Hydrodynamic Characteristic of Water Hammer Pump." *Journal of Fluid Science and Technology* 5.3 (2010): 491-502.

two types of air chambers they tested were a crosswise type and a lengthwise type, both of which allow for changes in capacity. The authors did not specify if they also added an air-holding device like inner tubes to their air chambers.

Our experimental setup also closely followed the one outlined in this paper. The water level in the reservoir tank was considered constant, and the flow into the pump was assumed to be equal to the flow injected into the tank (in our case, by the 3 L/s sump pump). They measured the lifting flow rate (the flow delivered by the pump) with the weighing method, which presumably involves converting the weight of the water ejected from the delivery line during a specified amount of time. This is a similar approach to our volumetric flow test, and possibly more precise. The drain flow rate (the flow wasted through the return line) is therefore represented by the difference between the input flow rate Q_i and the lifting flow rate Q_u . Pressure sensors installed immediately before and after the high pressure valve provided temporal pressure data, just as they did in our experimental setup.

The 2010 report included several interesting results relevant to our analysis. With regards to the air pressure chamber configuration, the authors found that the crosswise air chamber provided more head to the pump than the lengthwise air chamber. They suggest that a crosswise chamber results in a larger water surface area on which compressed air in the chamber can act, resulting in more available head. Although we chose not to test a lengthwise configuration due to its structural instability, this finding is relevant as we seek to minimize the size of the air chamber and test for maximum efficiency. They also found that air chamber capacity has minimal effect on available head, so as long as the air chamber we construct is equipped to accommodate the volume of water pumped during one cycle, there are no detrimental effects on pump performance associated with minimizing the size of the air pressure chamber.

While keeping the diameter of the delivery line (25 mm ⁶) and water level in the supply reservoir ($H = 0.5$ m) constant, the authors also examined the impact of varying drive pipe diameter (25 and 50 mm) on pump performance. For larger pipe diameters, the slope of the curve of pump head versus lifted flow rate was less steep than in the case of a smaller drive pipe, meaning that a higher volumetric efficiency is easier to achieve with a larger drive pipe diameter. Volumetric efficiency is equal to the ratio of the pump output to pump input:

$$\eta = \frac{Q_u h}{Q_i H} \quad (1)$$

where h is the pump head defined by the positioning of the outlet of the delivery line and H is given by the water level in the tank.

Additionally, the drain flow rate Q_d and the number of cycles per minute increase with drive pipe diameter. These findings could be relevant to the work of future Ram Pump teams as they experiment with different sized drive pipes.

The effects of changing the delivery line pipe diameter (25 and 18 mm) while keeping the drive pipe diameter constant (25 mm) were also examined.

⁶The symbol ϕ indicates the diameter of a circular section.

As in the case of a larger drive pipe diameter, a larger delivery pipe diameter resulted in a curve of pump head versus lifted flow rate with a flatter slope. In this case, however, the effect of changing the pipe diameter had little effect on the cycle time.

Finally, the authors varied the angle of the drive pipe as it enters the ram pump apparatus. Our design uses a system of elbows to achieve a drop in elevation before entering the relatively flat drive pipe, so we are not able to vary this parameter during testing. They discovered that the pump head ratio h/H decreases as the drive pipe angle increases, similarly to the change in performance of turbo pumps according to impeller outlet angle.

Their raw pressure sensor data is very similar to ours, a key characteristic of both curves being a small change in pressure in the high pressure line as compared to the pressure change in the drive pipe. Figure 7 on page 498 of their paper provides an excellent visual representation of pressure trends occurring each phase of pumping. Although we were not able to gather quantitative measurements of flow rate, the analysis of data presented in this paper provides a general idea of trends that future teams can anticipate and methods of analysis they can employ to draw conclusions on pump performance.

2 System Analysis

We developed a MathCAD document to characterize the testing parameters that we anticipated would most affect the modular pump performance. We will make decisions regarding the design of the full-scale pump based on experimentation with adjusting these parameters.

2.1 Head Loss

Head losses throughout the system are important to characterize because they cause the flow rate through the delivery (high pressure) line to decrease. We determined the major and minor head losses associated with three separate sections of the pump system: the region spanning the drive pipe entrance to the tee junction leading to the high pressure line, the region between the tee junction and the waste valve, and the region spanning the tee junction to the end of the high pressure line. These calculations enabled us to observe the effects of head losses on the flow rate through each respective section and to reveal which losses had the greatest influence on flow.

Equations 2 and 3 were obtained from the Fluids Functions file in the AguaClara source code:

$$h_f(Q, D, L, \nu, \varepsilon) = f \cdot \frac{8}{g\pi^2} \cdot \frac{LQ^2}{D^5} \quad (2)$$

$$h_e(Q, D, K) = K \cdot \frac{8}{g\pi^2} \cdot \frac{Q^2}{D^4} \quad (3)$$

Table 1: Assumed minor loss coefficients in the ram pump system.

$K_{liftcheck}$	10.3
$K_{swingcheck}$	2.2
K_{hpline}	2.2
$K_{drivepipe}$	0.5

where h_f is major head loss, h_e is minor head loss, Q is flow rate, D is pipe diameter, L is the length of pipe section, ν is the dynamic viscosity of water, ε is the roughness coefficient of PVC, f is the calculated friction factor, and K is the minor loss coefficient. K values used in our analysis are summarized in Table 1 below.

Head losses in the drive pipe section and the section leading up to the waste valve had minimal impacts on flow rate in calculations with both the lift check valve and the swing check valve. However, losses in the region between the tee junction and the end of the high pressure line proved to be significant. We chose to account for the overall inefficiency of the pump in this section because it contains two components most crucial to the operation of the pump: the air chamber and the check valve to the high pressure line. As a result, major and especially minor losses both contributed to a decrease in flow rate by nearly half. The maximum theoretical final flow rate exiting through the high pressure line Q_{final} , given an elevation drop h_{head} of 50 cm and a pumping height h_{pumped} of 78 cm, was calculated to be 0.406 L/s according to Equation 4:

$$Q_{final} = \frac{h_{head}}{h_{pumped} - h_{head}} (Q_{major} - Q_{unwasted}) \quad (4)$$

where $Q_{unwasted}$ is the lowest calculated flow rate in the high pressure region taking to account major losses and Q_{major} is the lowest calculated flow rate in the pump system taking into account major losses and not including losses affecting flow that exits through the waste valve.

2.2 Cycle Time

One of the stated goals of our experiment was to design the ram pump to operate at a suitable flow rate for filling a 55 gallon stock tank in about ten minutes. Therefore, cycle time for the pump is an important parameter to quantify. Equation 5, obtained from the Professor Monroe Weber-Shirk's PowerPoint presentation on hydraulic transients on the CEE 4540 website, relates cycle time to other important pump parameters we will optimize:

$$t_{cycle} = \frac{\tanh(0.9)^{-1}}{\left[\frac{g \cdot h_{drive}}{2 \cdot L_{drive}^2} (K + f \cdot \frac{L_{drive}}{d_{pipe}})\right]^{1/2}} \quad (5)$$

where t_{cycle} is cycle time, h_{drive} is available drive head, L_{drive} is the length of the drive pipe, K is the minor loss coefficient, f is the calculated friction factor, d_{pipe} is the drive pipe diameter. For a drive pipe length of 4.9 m (the initial

length we plan to test), a driving head loss of 0.244 m, and a K value of 0.5, the resulting t_{cycle} is equal to 4.11 seconds, which should serve as an estimate of the upper bound of the cycle times we expect to observe.

2.3 Mass Pumped Per Cycle

Theoretically, if energy is conserved for the system during each cycle of the ram pump, the mass of water pumped per cycle and thus the efficiency of the pump can easily be quantified. All water in the drive pipe, given a certain kinetic energy, will come to a full stop when the wasting valve closes. All that energy must then be converted into potential energy or a shock wave. We have assumed that the shock wave is insignificant compared to the lift energy of the pump. The maximum potential mass of water that can be pumped in a single cycle can then be calculated using an energy balance.

The mass of water in the drive pipe leading to the high pressure line carries a kinetic energy K_e that is dependent on the mass of water in the drive pipe M and the velocity of water in the drive pipe v :

$$K_e = \frac{1}{2}Mv^2 \quad (6)$$

The maximum flow rate our pump can provide has been calculated to be 0.406 L/s, so the velocity in the drive pipe was found to be roughly 1.48 m/s. The corresponding kinetic energy of this mass of water is conserved as the water moves up the high pressure line:

$$P_e = mgh \quad (7)$$

where P_e is potential energy, m is the mass of water pumped, and h is the height pumped. Assuming that water is being pumped to the ceiling of the lab and setting Equations 6 and 7 equal, the mass of water pumped per cycle was found to be 0.39 L. This method does not take into account head losses in the system, which we expect to be significant, so this estimate is likely high.

3 Methods

Our two major goals for this semester were to characterize and optimize a ram pump for implementation in an AguaClara plant. Elements of our design we sought to characterize included the pump itself, the test apparatus as a whole, and an orifice meter to measure flow rates. In addition, we considered how to incorporate the ram pump into future AguaClara plants.

3.1 Pump Characterization

Prior to designing our pump, we first researched ram pumps that have already been successfully implemented. In particular, we examined the plans developed

by Clemson University and the University of Warwick and based our preliminary ram pump designs, depicted in Figure 2, on their findings.

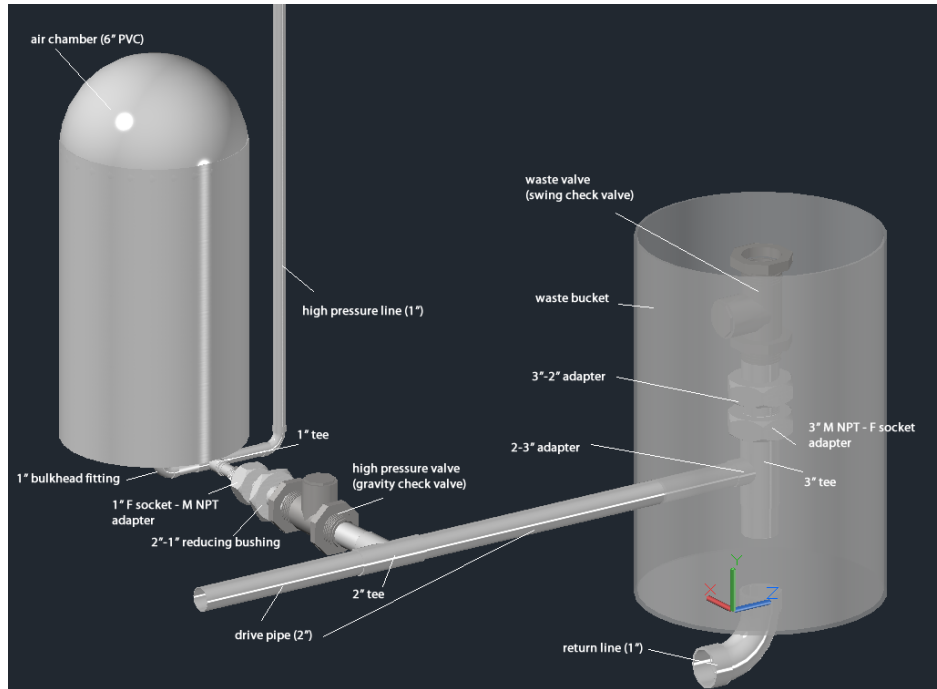

Figure 2: The ram pump, including high pressure line.

3.1.1 Pump Design

After gaining a better understanding of pump operation, we began designing our pump starting with an energy balance given a set elevation difference between the plant and the pump. Given 50 cm of elevation difference and 3 L/s of available plant flow, we calculated a maximum delivery flow of 0.406 L/s. We then designed the specific geometry and components of the pump using energy balance and head loss calculations. From these calculations, we also created a list of parameters to test and optimize. These parameters are listed below:

1. Type of waste valve
2. Size of air chamber
3. Length of drive pipe
4. Available elevation difference to the pump
5. Output flow rate



Figure 3: Waste valve and waste collection bucket detail.

Since we planned to test various valves and air chambers, it was necessary to design pipe connections facilitating ease of component removal and installation. For this purpose, we selected threaded pipe fittings for valves and air chambers given commercially available pipes, tees, and adapters.

In the literature, commercial valves as well as custom-built valves were investigated with respect to ram pump design. Custom-made valves may be specified to open under a specific pressure gradient by adding weight to the valve flap. However, fabrication in the field may be difficult. Thus, we planned to test commercially available valves prior to designing and installing a custom valve.

Currently, most ram pumps are designed for irrigation applications where water leaving the waste valve is allowed to drain into the environment. Since the water entering an AguaClara ram pump is treated potable water, a “valve-in-bucket” system was designed to collect water leaving the wasting valve and return it to the distribution tank. This is depicted in Figure 3 above. Although this system works well for testing on a small scale in the lab, we are not convinced that it is applicable to a ram pump in an AguaClara plant, where the valve might be placed in a tee in order to better control the flow of “wasted” water. However, it remains to be seen whether placing the wasting valve in a submerged environment like a tee would have interfere with certain aspects of pump performance, including the force required to reopen and reclose the wasting valve. This is a matter open for investigation by future teams.

3.1.2 Test Apparatus Design

After finalizing the design of the ram pump, we began designing the test apparatus to support the pump and pipes connecting the pump to the hydraulic testing facility. Since the waste valve opens and closes by redirecting the momentum of

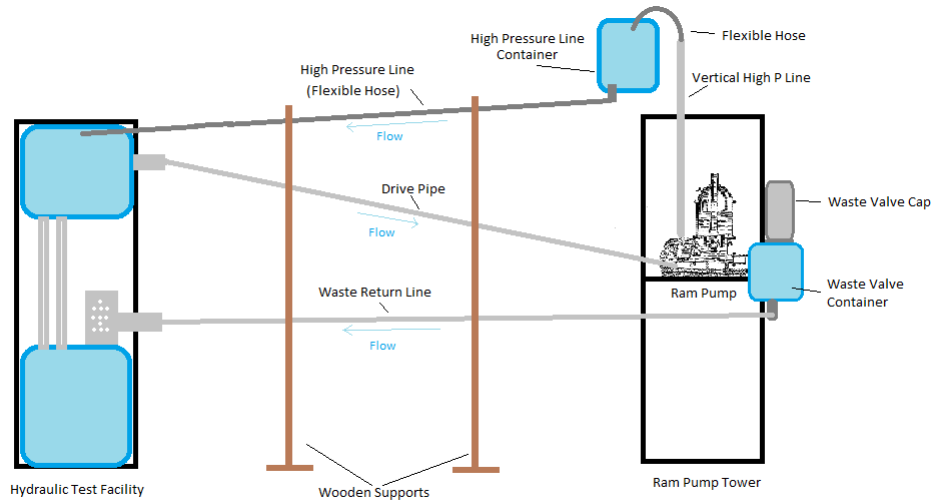

Figure 4: Hydraulic testing apparatus.

“falling” water to compress an air chamber, the structure of the testing apparatus must be capable of steadying any hydraulic hammer that may be created by the pump. Because the hydraulic testing facility is housed in an aluminum 80/20 frame, it was natural that the frame for the ram pump would also be constructed from the same material. The water flowing between the hydraulic testing facility and the ram pump also required physical support. The pipe supports were constructed to be adaptable to repositioning in order to test various drive pipe lengths. Lumber was selected as the cheapest material capable of supporting the pipes. Figure 4 below shows a schematic of the hydraulic test apparatus.

The hydraulic test facility was fitted with an LFOM, which is used to measure the amount of water wasted through the wasting valve. However, we decided to install five other points of measurement in order to gain a better understanding of the hydraulic transients of the ram pump. The measurement locations and their purpose are listed below:

1. LFOM (hydraulic testing facility): Measures the amount of water wasted through the wasting valve.
2. Pressure Sensor (hydraulic testing facility): Measures the height of water in the bucket for the purpose of calculating the total elevation difference available to the pump.
3. Beginning of Drive Pipe: Measures the pressure of water entering the drive pipe.
4. Beginning of Pump: Measures the pressure of water entering the waste valve.

5. Below Pressure Chamber: Measures the pressure of water entering the air chamber.
6. End of High Pressure Line: Measures the flow of water delivered by the pump, and thereby the potential “lift” of the ram pump.

We originally intended that the measured difference in pressures between the beginning of the drive pipe and the beginning of the pump would enable us to calculate total head lost through the drive pipe, and that the difference in pressure between the end of the high pressure line and below the air pressure chamber would enable us to calculate total head lost through the high pressure line and air chamber. These measurements would then facilitate the calculation of flow rate. However, traditional methods of calculating flow such as the work-energy equation do not apply to transient situations of unsteady flow. Additionally, there were too many losses throughout the system and too much “noise” in our eventual pressure sensor data to be able to draw solid conclusions about flow rate through the delivery line. Despite a lack of flow rate data, the pressure sensors located at the beginning of the pump and below the pressure chamber provided valuable information about pump cycle time, volume pumped per cycle, and maximum pressure reached within the system.

3.1.3 Orifice Meter Design

We also explored the option of constructing an orifice meter to measure the flow at the end of the high pressure line. In this design, the water in the high pressure line would be forced through a metal plate with a specified orifice as depicted in Figure 5. Pressure sensors installed before and after the plate would measure the pressure differential. Since flow rate varies with the square root of head loss through a submerged orifice, the pressure differential across the orifice would reflect the flow in the high pressure line.

In order to design the orifice meter for the proper level of resolution, we calculated the required orifice diameter $D_{orifice}$ for the range of flows through the orifice meter we anticipate observing. Equation 8 below, taken from Fluids Functions in the AguaClara source code, models the relationship between orifice diameter, flow rate, and head loss through the orifice meter:

$$D_{orifice} = \frac{d_{pipe}}{\sqrt{\Pi_{vc}(\sqrt{\frac{h_e g}{8} \frac{\pi d_{pipe}^2}{Q}} + 1)}} \quad (8)$$

where d_{pipe} is the diameter of the high pressure line pipe, Π_{vc} is the vena contracta coefficient for an orifice, h_e is head loss through the orifice, and Q is the rate of flow through the orifice meter. Head loss can be calculated via the equation

$$h_e = \left(\frac{d_{pipe}^2}{\Pi_{vc} D_{orifice}^2} - 1 \right)^2 \frac{8Q^2}{g\pi^2 d_{pipe}^4} \quad (9)$$

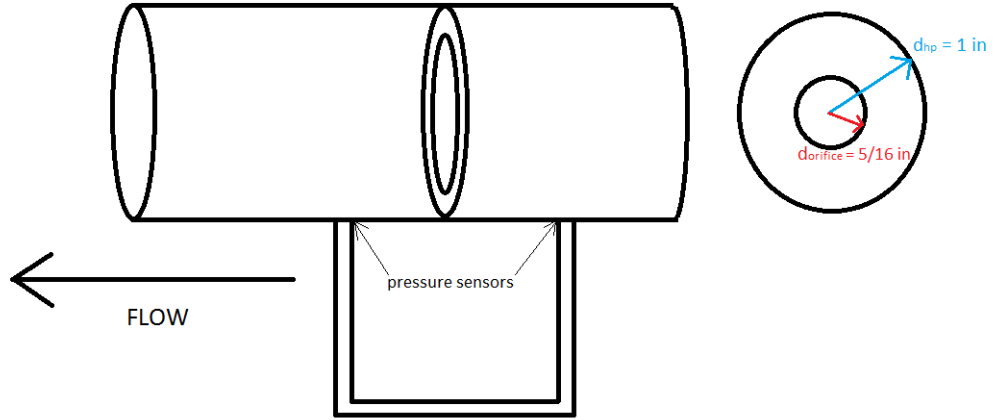

Figure 5: Orifice meter located at the end of the high pressure line.

Combining Equations 8 and 9 above into Equation 10 below, we developed a program in MATLAB and iterated through to find a suitable orifice diameter:

$$D_{orifice}(d_{pipe}, Q, D_{orifice}) = \frac{d_{pipe}}{\sqrt{\Pi_{vc} \left(\sqrt{\left(\frac{d_{pipe}^2}{\Pi_{vc} D_{orifice}^2} - 1 \right)^2 \frac{8Q^2}{g\pi^2 d_{pipe}^4} \frac{g}{\pi d_{pipe}^2} + 1} \right)}} \quad (10)$$

With a 5/16" orifice, we theoretically would be able to measure flow rates of 0.05-0.3 L/s with a pressure range of 1.2-45.7 kPa. This orifice diameter represents the best tradeoff between the maximum pressure and the range of pressures that the sensor can measure. However, qualitative observations collected during testing indicated that full flow through the delivery line was never quite achieved under a variety of pipe lengths and valve configurations. Because full flow through the approaching pipe is required for accurate flow measurement with an orifice meter, we decided to abandon this idea as well.

3.2 Location Within an AguaClara Plant

In addition to optimizing the pump, we also sought to design a pump that could be easily incorporated into an actual plant. To facilitate the incorporation of the ram pump into the AguaClara plant design, it would be convenient to install the pump in the pipe gallery of the stacked rapid sand filter (SRSF). Theoretically,

there would be approximately 3 m of head available to work with inside the filter. Moreover, since the pipe gallery is housed in concrete, installing the pump in the pipe gallery would reduce the amount of energy lost due to shaking of the pump apparatus. However, installing the pump inside the gallery would require minimizing the length of the drive pipe.

Since we will be pumping potable water, it will be required that wasting water be returned to the distribution line. While we would like to maximize the hydraulic head between the filter outlet and the ram pump, the pump must also be higher than the distribution tank to facilitate the return of water to the distribution line. Thus the location of the pump must also be optimized in future work.

4 Construction and Configuration Tests

Three specific elements of the ram pump presented construction and configuration challenges requiring particular attention: the air pressure chamber, the wasting valve, and the drive pipe. In this section, we examine each component in detail as well as compare options for a commercial and a custom-built wasting valve.

It was observed that in steady operation, the ram pump shakes the entire testing apparatus. In addition, the rubber boots (specifically the boot connecting the drive pipe to the ram pump) bulge dramatically with each cycle. A great amount of energy is lost with these motions. Furthermore, the shaking apparatus and bulging boots may present a danger hazard if the elevation head is increased. In addition to adjusting components of the ram pump, we therefore also sought to stabilize the testing apparatus with weight supports and reduce the problem of bulging boots with hose clamps in later designs.

4.1 Air Pressure Chamber

The current design for the air chamber calls for a threaded cap to be fitted with a 1" bulkhead fitting to connect the chamber to the rest of the pump. The threaded cap then screws into a threaded adapter which is solvent-welded to the 6" PVC pipe. The bulkhead fitting will not fit onto the cap without removing the knob on the cap which is used to tighten it. Removing the knob makes it difficult to screw and unscrew the cap from the chamber body. To remove the cap, we used a band saw to make the rough cut and then a lathe to smooth the cut until it was level with the rest of the cap. The hole for the bulkhead fitting was then bored out using the lathe.

An alternative method of construction may be to flip the air chamber over so that the welded cap is on the bottom of the air chamber and the threaded cap is on the top. This design would make it easier to replace the inner tubes in the chamber and would not require the knob on the threaded cap to be removed. A lathe would still be necessary to drill a hole in the welded cap and it may not

be able to make an airtight seal between the cap and bulkhead fitting because the welded cap is convex.

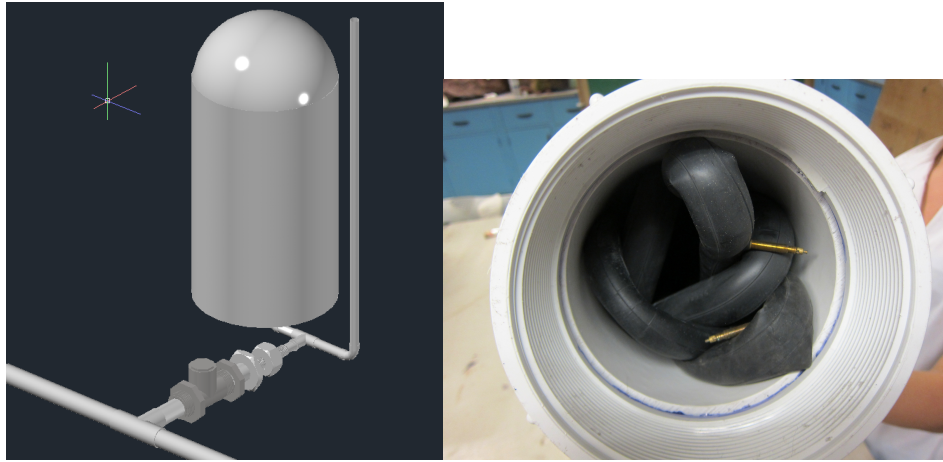

Figure 6: Air chamber detail.

In the current design, the air chamber is sized based on its volume. The chamber is then filled with inner tubes, shown in detail in Figure 6, to hold the air in the chamber. Because the tubes take up some space of their own, the actual volume of air will be slightly less than the volume of the chamber. This will likely not be an issue since the recommended volumes range over an order of two and the tubes will not take up that much space. What may present a larger problem is arranging the tubes to fit into the air chamber. Because the tubes are circular, they do not fit in the chamber very well when they were inflated and left a fair amount of unfilled space in the chamber. These dead spaces might be filled in a bit as more tubes are added, but it is unlikely that they will ever be completely eliminated.

Changing the type of air bladders may help eliminate the problem of dead space in the air chamber. Instead of using bicycle inner tubes, it might be possible to use bubble wrap or some other packing material. Longevity may be an issue if packing material is used since it is generally not designed for repetitive loading cycles. It may also be possible to use some other vessel as an air chamber in which it is easier to fit bicycle inner tubes.

In the ram pump designs reported in the literature, the air chamber has been included to absorb the shock wave. However, in our hydraulic analysis of the pump, we concluded that the water is pumped not by the shock wave but by a transfer in momentum. Currently, the pressure chamber rises 96 cm above the pump with a diameter of 6". Thus it may be possible to reduce the size of the pressure chamber, if not eliminate it entirely. Based on the ideal gas equation,

$$pv = nRT \quad (11)$$

we modeled pressure in the air chamber as a function of its volume. Using the rough guideline of sizing the air chamber to 50 times the volume pumped per cycle, which we found to be around 4.5 mL for most pump configurations, we determined the minimum volume air chamber possible was 0.225 L. This, however, corresponds to a pressure of 2708 kPa, whereas a 3.05 L air chamber would experience pressures of 200 kPa (the maximum range of our current pressure sensors). Further testing is necessary to determine the optimum air pressure chamber size.

4.2 Commercial Wasting Valve

The wasting valve gradually evolved into one of the more complicated portions of the pump. Our first iteration of the ram pump utilized a commercial 2" PVC swing check valve with the pump located 91 cm below the water source. The pump was allowed to run for about 15 minutes to reach steady operation.

The flow out of the high pressure line was so small that it could not be recorded from a volumetric flow test. It was concluded that the commercial wasting valve was extremely inefficient due to its location above the pump. To connect the commercial wasting valve to the wasting tee, two adapters and three short sections of PVC piping were required. Thus the valve was actually located roughly 25 cm above the wasting tee, greatly reducing the amount of head available to the pump. The adapters and all sections of pipe are necessary for the test pump but could be eliminated in the final design; however, this would mean that the valve would not be replaceable and if it failed, the entire pump would need to be replaced.

From this test, we concluded that a custom wasting valve would be the best option worth exploring.

4.3 Custom Wasting Valve

The homemade wasting valve design is currently in its second iteration (see Figure 7) and is constructed out of a 3"x4" pipe nipple and a solvent-welded 3" cap. Using just a 3" threaded cap was not feasible because it was impossible to drill enough holes in it so that the water in the drive pipe could rapidly come up to speed. The current iteration solves this problem by letting water out through holes in the side of the nipple that is screwed into the pump body. The new design is more difficult to build than the first. It requires a baffle that fits inside the 3" nipple and catches the valve flap as it moves up with the flow of water. It also requires a threaded hole in the center of the cemented cap to hold a 1/2" nipple which acts as a sleeve to hold the sliding rod. Both the baffle and the cap must be turned on a lathe to be manufactured. While these parts are easy to make in the lab, it may be more difficult to build in the field and will certainly be more expensive.

The wasting valve is connected to the ram pump via a 3" tee. The bottom of the tee is threaded and capped to facilitate drainage. However, it is difficult to remove this cap because the wasting apparatus is housed within a bucket.

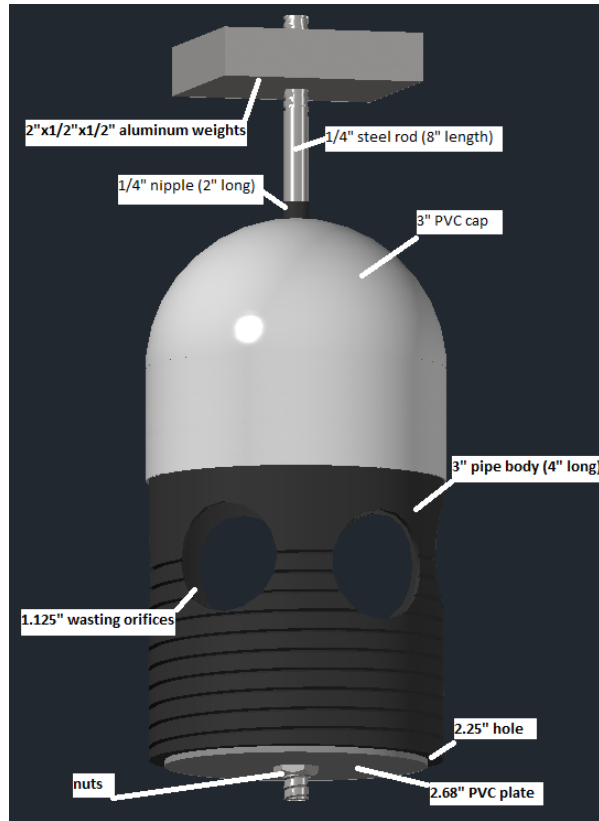

Figure 7: Custom wasting valve in its second iteration.

As future teams optimize the wasting valve, we recommend that they explore alternative caps to facilitate drainage of the wasting valve.

While our custom valve is very effective in pumping water and facilitates tuning, the plastic nipple wears quickly against the metal rod. It may be necessary to replace the plastic nipple with a metal version.

4.4 Short Drive Pipe

To facilitate installation of the pump within the SRSF it was necessary to minimize the length of the drive pipe. Given the physical setup of the hydraulic testing facility and the ram pump cradle, a drive pipe of 3' was tested under 60 cm of head. Under these conditions, no water was pumped. Since pressure sensors and a data collection box were not available, we could only speculate as to why the pump failed.

Firstly, the cycle time of the wasting valve was very erratic. Despite adding more weight to the wasting valve, the cycle time never reached steady state

nor was any water pumped. Secondly, it was unclear whether the high pressure valve was cycling with the wasting valve. Upon touching the valve, it did not seem to be cycling. Water was found, however, to have entered the high pressure chamber, signifying that the high pressure valve did open at least once during testing.

Secondly, there may not have been enough energy to lift the water up and over the bend in the high pressure line. The energy available to the pump was reduced by shaking of the apparatus during operation; with a drastically shorter drive pipe, we believe that the mass of water in the drive pipe was too small and therefore the available momentum insufficient to overcome these energy losses. Additionally, in this test, not only was the drive pipe length shortened but the available elevation difference reduced as well. While the relationship between the length of the drive pipe and the performance of the pump has yet to be clarified, the reduced head definitely reduced the energy available to the pump.

Given less energy, there are two possible scenarios that could potentially account for the observed pump failure. Either the water was simply passing back and forth through the high pressure valve, or there simply was not enough energy to open the high pressure valve. In either case, the result is zero net flow. However, without pressure sensors to perform a detailed analysis of the pump, a clearer understanding of the pump's failure could not be illuminated at the time.

In this initial test, two control variables had been changed: elevation head available to the pump and drive pipe length. In the second round of testing, we sought to evaluate each of these variables separately while keeping the other constant in order to elucidate the critical points of our design.

Utilizing the same 3' drive pipe setup, we increased the head available to the pump to approximately 100 cm with a system of elbows connecting a short length of pipe inserted immediately before the straight section of drive pipe. Ultimately, this design decision proved to be disastrous, as the forces associated with water flowing at a rate of 3 L/s through two consecutive 90° bends were significant enough to cause the unglued pipe elbows to burst. In order to rerun the test and collect data, it would have been necessary to glue the pipe sections. However, doing so would have detracted from the modular nature of the pump, as it would then have become more difficult to adjust the available head for subsequent tests. Because initial evidence indicated that an extremely short drive pipe was likely unfeasible, we decided to conduct further tests with a 10' drive pipe in order to characterize our design parameters (including available head). Short drive pipe testing was placed on an indefinite hold.

5 Initial Results

The first round of tests were performed with 91 cm of head, a 20' drive pipe, a drive flow of 3 L/s, and a pumping height of 167 cm. Based on Equation 4, the theoretical maximum flow rate possible given this configuration is 0.72 L/s. Tests were conducted to determine the potential effects of changing the stroke

length of the wasting valve on pump performance. Tests were also conducted to determine the effect of increasing the closing velocity of the wasting valve on pump performance. This was accomplished by varying the mass attached to the sliding rod. Figure 8 summarizes the results as the mass was varied.

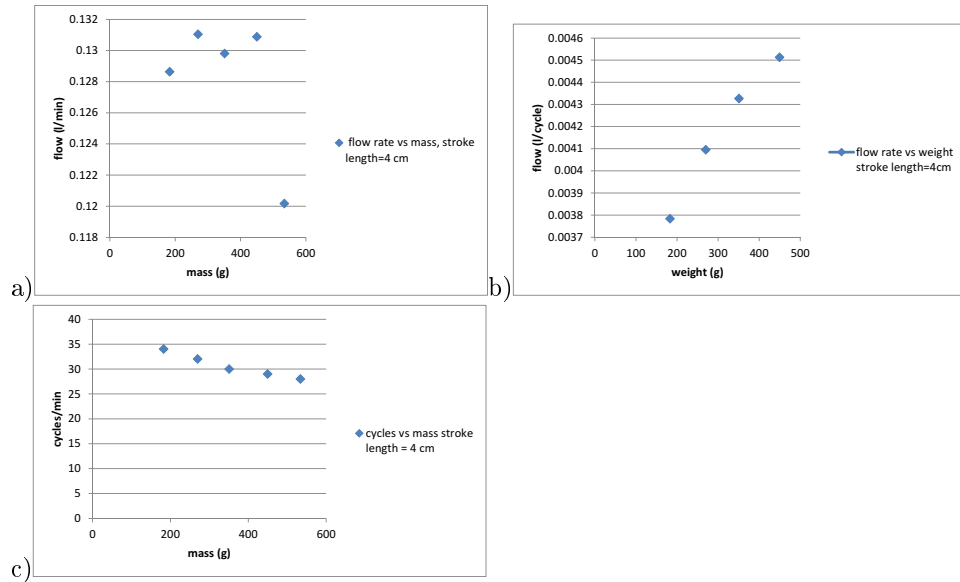

Figure 8: Graphs of (a) the effect of varying mass on flow rate, (b) the effect of varying mass on volume per cycle, and (c) the effect of varying mass on frequency, with a stroke length of 4 cm.

Increasing the mass on the wasting valve did not appreciably affect the flow rate until the mass added was over 550 g. At that point, the cycling became erratic and the flow decreased. As the mass on the wasting valve increased, the frequency of the pump tended to decrease, and this led to a trend of increasing volume pumped per cycle. The likely reason for this increase in pumping efficiency is higher closing velocities at the valve. Since kinetic energy increases as the square of velocity, a small increase in closing velocity can represent a significant gain in flow. This increase in pumping energy appears to be balanced in these tests by the lower number of cycles per minute, thus negating any overall gains in flow.

Figure 9 shows the effects of varying the stroke length of the valve on pump performance.

Varying the stroke length did not appear to have much effect on the flow from the high pressure line, nor did it seem to affect the pumping efficiency; however, there was an observed decrease in frequency as the stroke length was increased. It is difficult to say with certainty why stroke length did not appear to have any effect on the flow rates achieved by the pump. It was observed during testing that the flap on the wasting valve extended below the entrance

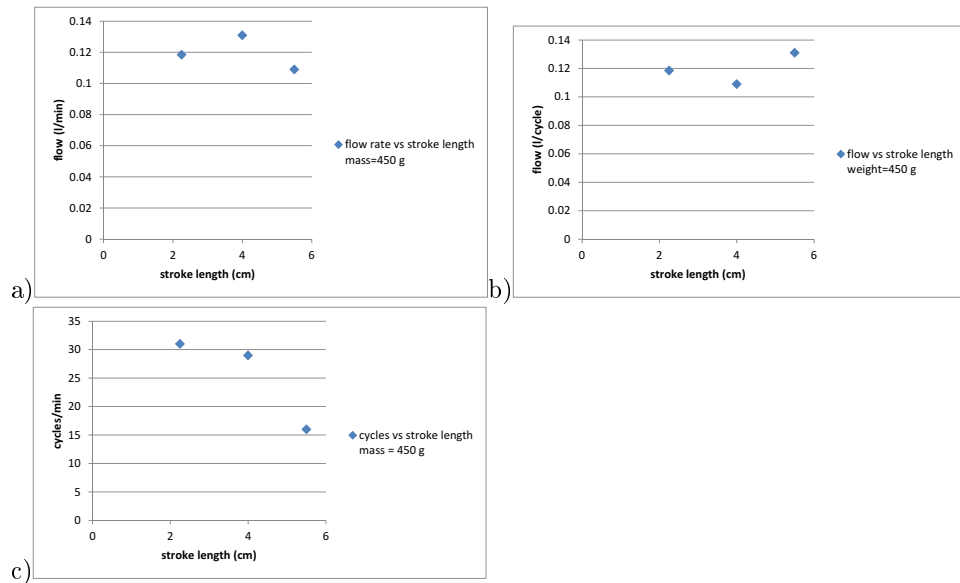

Figure 9: Graphs of (a) the effect of varying stroke length on flow rate, (b) the effect of varying flow rate on volume pumped per cycle, and (c) the effect of varying flow rate on the frequency of the pump, with a mass of 450 g.

to the tee for longer stroke lengths. This probably means that some of the flow moves over the top of the flap creating a certain amount of down force. This may negatively affect the pump performance.

None of the configurations tested were particularly efficient. The best performance achieved was 18% of the theoretical maximum flow rate that could be achieved with the tested configuration under ideal conditions. Literature on ram pumps suggests that most pumps can achieve efficiencies of around 60% and that higher efficiencies are possible. Although there are many sources of energy losses in the current design, two are particularly worth noting. Each time the valve closes, the water in the drive pipe should decelerate as the energy is used to force water up the high pressure line. During testing, the particles suspended in the water could be seen first stopping when the valve closed then rebounding back up the drive pipe. This suggests that every time the valve closes, the flow is actually reversing and not all of the energy is being directed towards moving water into the high pressure line. The entire testing apparatus also shakes violently every time the pipe cycles. This means that some of the momentum is not being used to move water up the high pressure line and is instead being used to accelerate the pump, frame, drive and return lines, and tower of power. This may very well represent a significant loss of energy in the system.

6 Pressure Sensor Data

For our second round of testing, we were able to obtain and install 200 kPa pressure sensors at two locations in the ram pump apparatus: one at the end of the drive pipe right before the water enters the pump, and one in the high pressure line. Figure 10 shows times in which the pressure recorded in the drive pipe exceeded pressure recorded in the high pressure line indicate intervals in which the pump was pumping water. From this information, we were able to make both qualitative and quantitative observations about the effects of varying the stroke length and weight added to the custom waste valve on the frequency of the pump, the peak pressure, the flow, and the volume of water pumped per cycle. All tests were conducted with a 10' drive pipe and a 2.68" diameter plate on the wasting valve.

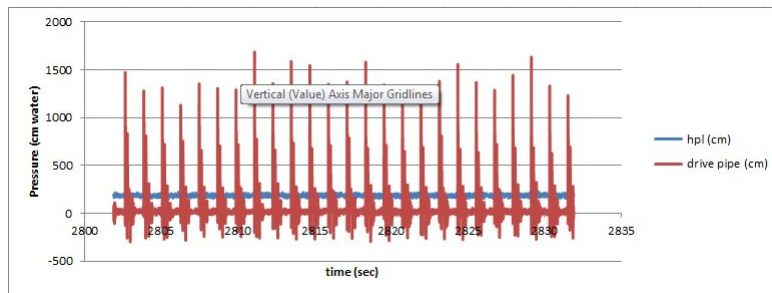

Figure 10: Raw sample data obtained from a pressure trace in the drive pipe and high pressure line showing the gauge pressures in each during operation.

6.1 Frequency

As indicated in Figure 11, varying stroke length and weight added both had an appreciable effect on the frequency at which the pump operates. Increasing stroke length and mass both resulted in fewer cycles per minute and a lower pump frequency. These observations were in line with expectations, as adding more weight increases the force needed to open and close the valve, and more time is required to build up a higher corresponding pressure in the drive pipe. Further tests conducted with different sized plates on the wasting valve may reveal more information about the interaction between these variables.

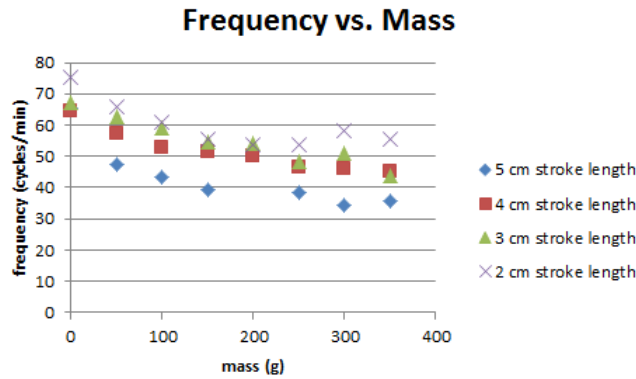

Figure 11: Pump frequency as a function of mass added and stroke length.

6.2 Peak Pressure

Increasing mass and stroke length generally corresponded to higher peak pressure values observed across the recorded interval of measurement as shown in Figure 12. Although higher pressure values indicate larger flows and a higher level of efficiency achieved by the pump, analyzing pump performance using peak pressure values could lead to misleading conclusions because we also observed that the pump operated more unsteadily as the mass added increased.

Higher peak pressures were observed for longer stroke lengths, but peak pressures associated with the 5 cm stroke length lie outside the recordable range of our pressure sensors. In order to draw more robust conclusions on pump performance with a 5 cm stroke length, these tests should be rerun with larger pressure sensors and a larger range of weights.

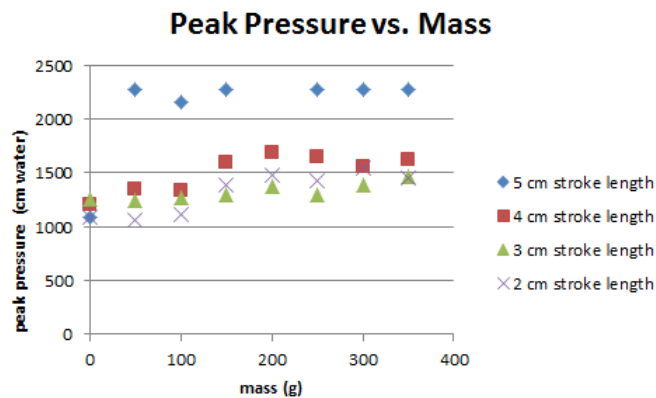

Figure 12: Peak pressure values observed in the drive pipe as a function of mass added for various stroke lengths.

6.3 Average Flow

Figure 13 shows the average flow rate, in mL per minute, of the pumped water as measured by a volumetric flow test. In general as the weight increases, the average flow rate increases as well. The 5 cm stroke length is the exception to this case. The volume pumped appears to increase and then decrease as the weight continues to increase. This is likely because the closing velocity is too high, which makes the cycle time is too long thus leading to lower output. It seems likely that all stroke lengths should share this characteristic, but it was not observed because it was not possible to add enough weight to the valve.

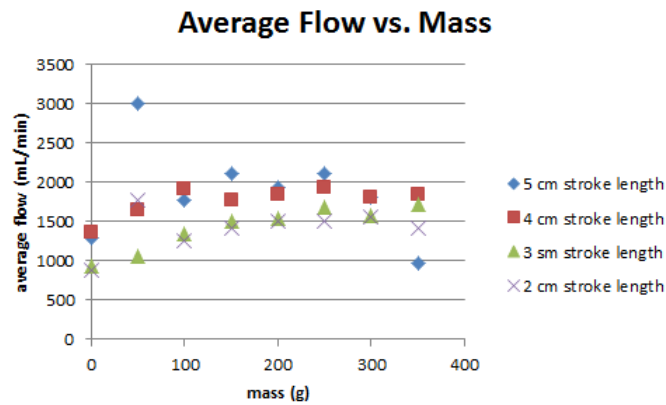

Figure 13: Average flow recorded during bucket tests for a range of stroke lengths and mass added.

6.4 Volume Pumped Per Cycle

Figure 14 shows the volume of water pumped per cycle of the pump. Unlike in initial testing, there is only a moderate increase in efficiency observed here as the mass on the valve increases. This again may be due to the fact that not enough weight was added to the valve to change the closing velocity very much. This may become more clear once the testing rig has the capabilities to measure instantaneous flow rates in the pipes.

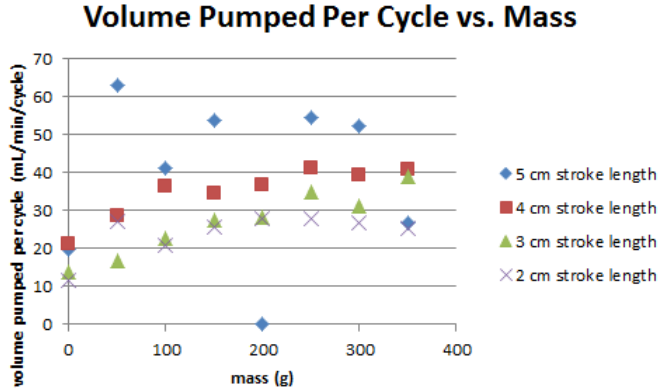

Figure 14: Average volume pumped per cycle as a function of mass added and stroke length.

7 Data Acquisition

With each new test we uncovered new limitations in the laboratory data collection system. Due to the non-steady-state nature of the ram pump, we were unable to capture instantaneous flow rate data. A pitot tube style measuring device may be able to capture the velocities in the drive pipe, allowing future teams to correlate them with the pressure data. It would also be interesting to observe what the valve is doing during each cycle, specifically when it is open and closed. We attempted to build a sensor which closes a circuit when the valve is open and relays that information to the data collection network. Unfortunately, the device overloaded the available equipment, forcing us to place that idea on hold. Future teams may want to revisit the device and modify it so that it can be integrated into the data collection network.

We also discovered that during some of our tests we were overloading the 200 kPa pressure sensors. This means that the water hammer caused by the closing valve was producing a pressure wave greater than 22 meters of water. Although we still analyzed cycle times from the overloaded pressure traces and obtained a good estimation of pumping time, maxing out the sensors did limit our ability to analyze the maximum height of water that could be pumped and prevented us from being able to analyze the magnitude of the shock wave. Acquiring and installing higher rated pressure sensors will alleviate these problems.

The greatest challenge to instantaneously analyzing the ram pump is that the Bernoulli equation cannot be applied. The Bernoulli equation assumes steady state and no headloss in the system. Unfortunately, the hydraulic transients of the ram pump violate these conditions. The Navier-Stokes equations, on the other hand, could be applied to the ram pump.

The Navier-Stokes equations assume that the fluid in question is a Newtonian fluid undergoing incompressible flow. Although the literature has suggested

that closing the wasting valve sends a shock wave up the drive pipe, the significance of this wave has yet to be clearly defined. Any fluid compression caused by the closing of the wasting valve may be small enough such that the Navier-Stokes equations can be applied. Following this assumption, the Navier-Stokes equations can be applied to the ram pump. However, the instantaneous velocity is required to calculate the instantaneous flow rate. Since the pitot tube data collected so far was found to be too noisy, the instantaneous flow rate could not be calculated.

7.1 Future Data Analysis Improvements

7.1.1 Pressure Sensor Ports Closer Together

A pitot tube attached to a pressure sensor and a second pressure sensor connected directly to the pipe can be used to measure the velocity to the pump. Since the wasting valve creates a shock wave that reverberates through the drive pipe, the pitot tube sensor will measure both the velocity through the pipe and the magnitude of the shock wave while the second pressure sensor will measure only the shock wave. Thus, the pressure sensor data can be subtracted from the corresponding data value of the pitot tube reading to yield the velocity head. Currently, there is a distance of about 30 cm between the pressure ports. This creates a time lag between the two pressure ports. Subtracting the pressure sensor data does not actually eliminate the shock wave effects from the pitot tube reading since the two ports are registering different shock waves. Therefore, the resulting value is not actually the velocity head.

To alleviate the time lag, a new configuration should be used where the the pitot tube and the second pressure sensor are connected at the same point along the pipe. This way, the readings of the second pressure sensor and the pitot tube will simultaneously measure the same shock wave as it passes one point.

7.1.2 Use of 7kPa Sensor on Velocity Meter

If the pitot tube and the second pressure sensor can be installed at the same point along the pipe, a single pressure sensor can be placed between the two ports to measure only the velocity. This way, the individual readings from each port do not have to be manually subtracted to yield the velocity into the pump.

Currently, 200kPa pressure sensors are being used. The greatest challenge with these sensors is that the noise on the system detracts from the actual data. Thus, a moving average is needed to smooth the velocity data. Since the magnitude of the velocity will be small, a 7kPa instead of a 200kPa pressure sensor can be used. With a smaller range, the 7kPa sensor readings will not record as much noise from the sensor itself as is observed for the larger sensors.

7.1.3 Flow Analysis of the Pump

If the velocity meter can be installed with a 7kPa pressure sensor, then the Navier-Stokes equations can be used to calculate the instantaneous flow into

the pump. Should the velocity meter fail, it may be possible to install an LFOM on the overflow line of the hydraulic test facility and a second LFOM on the sump pump to calculate the flow delivered to the pump. Given the flow and the configuration of the sump pump, an orifice meter may be more realistic. However, to calculate the efficiency of the ram pump, the instantaneous flow delivered from the pump must also be measured.

To measure the instantaneous flow of water delivered by the pump, it may be possible to install a small LFOM on the high pressure line. The greatest challenge, however, is that the flow leaving the pump is very small. If attached to the high pressure line, the LFOM would have to be sensitive to such small amounts of flow.

Volumetric flow tests on the high pressure line can be used to calculate the efficiency of the pump given the maximum flow through the drive pipe. However, the greatest challenge with volumetric flow tests are that they are not particularly accurate. The efficiency calculated from the volumetric flow test would also only yield the maximum efficiency of the pump. Little information regarding the cycles of the pump can be gathered from the tests. For these reasons, instantaneous flow analysis is preferred.

8 Pump Upgrades and Design Considerations

There is a considerable number of upgrades that may be made to the pump based on the work of future AguaClara teams. These design considerations apply not only to the pump itself but also to the hydraulic testing facility to ensure more accurate analysis of the modular pump.

8.1 Pump Modifications and Reconfigurations

The current valve configuration on the pump may be negatively impacting pumping efficiency. Currently, the wasting valve is located at the very foot of the drive pipe and the high pressure line tees off a little further up the drive pipe (see Figure 2). Every time the pump cycles, the water between the wasting valve and the high pressure line must come to a nearly instantaneous stop. Figure 15 shows how the water flows through the pump during the acceleration phase. Figure 16 shows the flow of the water in the pump during the deceleration phase. During the deceleration phase, the pressure is provided by the water flowing down the drive pipe and into the high pressure line. That same pressure gradient prevents the water between the high pressure line and the wasting valve from flowing through the high pressure valve. The energy in the trapped water must somehow be dissipated for each cycle, and it seems likely this is accomplished through a water hammer.

This compressing and decompressing water may also explain why the flow in the drive pipe can be observed flowing upstream at the end of each cycle during some tests. During the deceleration phase, the water also must make a 90 degree

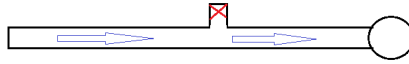

Figure 15: Current flow pattern during the wasting phase.

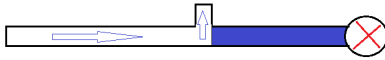

Figure 16: Current flow pattern during the pumping phase.

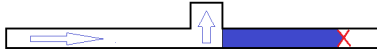

Figure 17: Reconfigured flow pattern during the wasting phase.

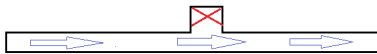

Figure 18: Reconfigured flow pattern during the pumping phase.

turn to enter the high pressure system. This turn likely causes significant losses of energy and a corresponding loss in efficiency.

Figure 17 and Figure 18 show how the pump could be reconfigured to help mitigate the shockwave and eliminate the 90 degree bend. This design would require swapping the positions of the wasting valve and the high pressure line. In doing so, the water is ensured a straight shot into the high pressure line during the deceleration phase and no dead water needs to dissipate energy each cycle. The more direct path the water travels during deceleration, as well as a reduction in the water hammer, may also reduce the shaking in the testing apparatus.

Although this design will likely lead to better pump performance, it will make construction of the pump and installation more difficult. Instead of being able to attach a capture device to the end of the drive pipe to collect the wasted water and send it to the distribution tank, a device will have to be fitted around the drive pipe. This change in design would make it difficult to enclose the wasting valve in a larger tee and would require two sealed connections around the drive pipe. It would also be difficult to remove such an inline enclosure to service or remove the wasting valve. Given those complications in design, the best compromise might be to minimize the distance between the high pressure line and the wasting valve. Although this would not eliminate the 90 degree angle in the flow, it would minimize the water hammer by reducing the amount of energy that needs to be dissipated.

The reverse flow observed in the drive pipe during the end of each cycle might also be caused by backflow out of the high pressure line. The current design uses a 2" swing check valve to control flow in and out of the high pressure system. This was done to minimize headloss and to integrate well with the rest of the piping in the high pressure system. Headlosses are high enough in the drive pipe that at 60 cm of head, the water in the hydraulic testing facility goes through the overflow rather than all through the ram pump. This, along with the various energy losses associated with the current design of the pump and testing facility, led to much lower flows in the high pressure system. This means that the current valve is very much oversized for the application. Because of the large size of the valve, it is possible that it is not closing quickly enough to prevent some of the water in the high pressure line from flowing back into the drive pipe at the end of a pumping cycle and creating some back flow in the drive pipe.

A smaller high pressure line valve might improve pump performance in two ways. First, it might have a faster closing time which would prevent water being lost out of the high pressure system. Secondly, it might have a quicker opening response which could be important since the pressure traces shown in Figure 10 seem to show that during one cycle, the pressure in the drive pipe oscillates above and below the pressures in the high pressure system. This may mean that the high pressure line valve opens and closes multiple times during a cycle. Using a different kind of check valve may also improve performance. The current valve relies on gravity to close, and only works in one orientation. The system may work better if the current valve is replaced with a ball check valve

or something similar. Ball check valves close because of a spring, which would eliminate the directionality of the valve and might reduce the closing time. A spring closed valve would also increase the force required to open the valve. Based on the pressure data collected thus far, the pump can easily overcome that additional resistance, but it is possible it might have a negative effect on performance.

8.2 The Custom Wasting Valve

Although the custom-made wasting valve has much better performance than the modified commercial valve, it is not without problems. It is somewhat difficult to tune, its parts seem to wear rapidly, and it requires some fairly heavy machining to produce. Although the design will never be perfect, some design changes may be able to lessen these problems.

Tuning the valve requires an operator to adjust the stroke length and weight on the valve and to measure the resulting output to determine the proper configuration for maximum efficiency. This is a time-intensive process and represents the bulk of the testing done on the pump thus far. Fortunately, this will probably only have to be done once when the pump is first installed. After that, assuming that the flow rate in the drive pipe and the height to which the water needs to be pumped do not change, the most efficient configuration should remain the same. The process will be made easier if a production pump is tested and tuned on the hydraulic test facility for a variety of conditions. The results from those tests should get ballpark values for a tuned pump, thus expediting the process.

The wasting valve design requires a sliding rod that attaches to the weights (see Figure 7) and guides the flap over the baffle. The sliding creates wear on the sleeve holding it and tends to wear it out quickly. The current valve uses a steel rod and a PVC nipple as a sleeve. The rod is free-floating in the sleeve so that there is a minimal amount of friction, but this allows it to ride against the top and bottom edge of the nipple. The valve initially used a 2" nipple which wore out within a couple of weeks. It is now equipped with a 4" nipple which is still in good shape after a month of fairly frequent testing, but it is showing signs of wear. Another contributing factor to the relatively long life of the 4" nipple may be the switch to symmetric weights. During initial tests, asymmetric weights were used to tune the waste valve. These weights created a moment about the rod and lead to greater wear on the nipple. The current weight set is balanced around the rod, so there is no net moment.

The sliding rod configuration deserves more attention since it is likely to be the primary failure point on the pump. There are several options for improving the design, including changing materials and adjusting tolerances between parts. Making the sliding rod and sleeve out of the same material should reduce wear and spread it more evenly between the two parts. Making the parts out of stainless steel will increase the longevity and reduce rusting, but it may require minor design changes. Steel pipe fittings have different standard dimensions than PVC fittings which prevented the current nipple from being replaced with a steel one.

It is also possible to replace the steel rod with a PVC one, but the components will probably not last as long as steel ones and are not markedly less expensive.

There is a 0.0125" gap between the rod and the sleeve on the wasting valve. This allows the valve to pivot slightly and wear down the lips of the sleeve. Decreasing the gap would reduce the amount of wear on the sleeve, but would also increase friction in the sliding mechanism. To combat the friction, some sort of lubrication might be necessary. This presents a challenge in the context of an AguaClara plan because treated water will be running through the pump and cannot become contaminated by lubricants. The water that gets into the sleeve may be sufficient lubrication, but this has yet to be confirmed by testing.

8.3 Shaking Analysis

Every time the ram pump cycles, it shakes between 1.5 cm and 2.5 cm. This shaking represents a loss in energy and thus a loss in pumping capacity. To determine the extent of these losses, the theoretical volume of water pumped per cycle without taking shaking into account should be calculated and compared to observed values. The difference should represent losses due to materials, valve responses, and head losses.

The total distance the water moves down the drive during deceleration is the theoretical maximum amount the ram pump can pump. The acceleration can be calculated based on the pressure in the high pressure line, the maximum velocity in the drive pipe, and the length of the drive pipe. The force acting to decelerate the water in the drive pipe is provided by the high pressure line and can be calculated as

$$F = PA \tag{12}$$

where F is the force acting on the water, P is the pressure in the high pressure line as measured by the pressure sensor, and A is the cross-sectional area of the drive pipe. The acceleration can be calculated from

$$F = MA \tag{13}$$

where M is the mass of water moving in the drive pipe and A is the acceleration of the water. Based on a drive pipe 4 meters long including the pump body and a 2 meter hydrostatic pressure provided by the high pressure line, there is 2.0258 kg of water moving in the pipe and it decelerates at 19.63 m/s^2 . The time it takes the water to stop can be calculated from

$$v = at + v_0 \tag{14}$$

where v is the final velocity in the drive pipe, v_0 is the initial velocity in the drive pipe, a is the acceleration of the water, and t is the time it takes the water to stop. Assuming the worst case scenario where the drive pipe is flowing at its theoretical maximum velocity of 1.5 m/s and the final velocity is zero, the time it takes for the water to decelerate is 0.0764 seconds. The distance the water moves in that time can be calculated by

$$x = -\frac{1}{2}at^2 + v_0t \quad (15)$$

Based on the characteristics of the ram pump, the water should travel 0.0865 m down the drive pipe. This seems to agree with the observed flows in the drive pipe. During cycling, the pump moves between 1.5 and 2.5 cm. This movement represents lost potential pumping power. Based on the area in the drive pipe and the shaking of the pump, 0.031 L should be entering the drive pipe every cycle. The highest observed pump efficiency was 0.0045 L/cycle, which indicates that there are fairly high losses in flow associated with valves and head losses in the system.