

## **2004 Modified Solar Oven Design**

ESW Service Learning Course at Cornell University. Advisor: Tim Bond

Members Involved: Yosef Bronsnick

---

A third oven used for testing was built this semester. The rough plans for the third oven were drawn up last semester and were based on the solar oven design from the S.T.E.V.E.N. foundation. Exact plans for the third oven have been completed and are attached in Appendix E.

The design of a third oven was determined to be extremely necessary early on in the fall 2004 semester. The current ovens that the team has been using for testing are very bulky and awkward to use. The ovens are currently loaded from the top which means that the reflecting panels must first be detached from the ovens before the top glass may be removed in order to get to the pot. Removing the reflectors is difficult for one person to do alone. Additionally, the boxes are also propped up on brackets so that the top face of the box and the solar collector are at an angle towards the sun. The problem with this current system of angling the box is that the system is very unstable and the boxes can slip off of their brackets which would result in the pots spilling. The group felt that these two deficiencies, having to remove the reflectors to access the oven contents and the oven instability, were so bad that they would eventually lead to the abandonment of the solar cookers by our partner organizations. The group was also concerned with the ease with which the ovens could be constructed and the materials each community had available to build the ovens.

The third oven was designed taking into consideration the features the oven needed to have in order to become more acceptable to our partner community. However, the main focus of the oven was to solve the problems of ease of use. Several ideas of possible ovens had been discussed during the design phase of the third oven. One design called for a conical reflective panel rather than the current trapezoidal design but this was determined to be too difficult to attach rigidly to the cooker. Another idea was to have the pot hang inside the oven that way when the box is tilted towards the sun gravity

would cause the pot to hang perpendicular to the ground and thus the current angled seats placed inside the ovens could be removed. This also proved to be not entirely adequate. Collapsible reflector panels were also considered, but it was determined that these would be overly difficult to build.

The third oven final design includes a hinged back door instead of being top loaded. This back-door design is similar to the oven our Ecuador contact is currently using. The oven walls are larger at the back and shorter in the front, thus forming a permanent sloping top to which the reflector can be attached. The sloped top removes the necessity to prop the box at an angle so that the collectors face the sun. While the optimum angle for our Moroccan partners was found this semester, the optimum angle for the community in Ecuador has still to be determined. For this oven, we chose an angle that was optimum for late May through early July in the Ithaca area. The ovens are also designed with a trapezoidal collector which has the same configuration as the reflectors used on the original two ovens.

DESIGN OF SOLAR BOX COOKER

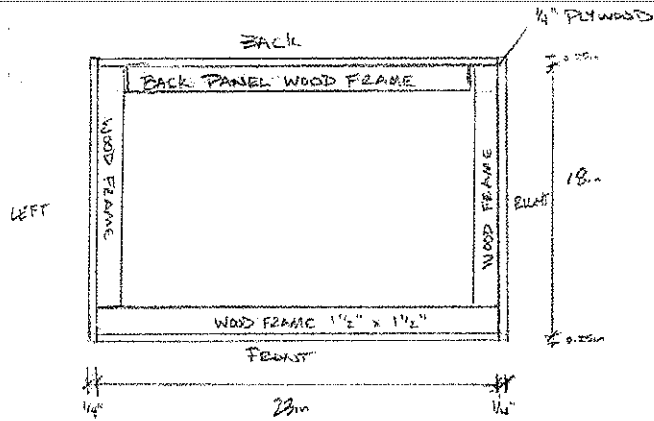

PLAN VIEW

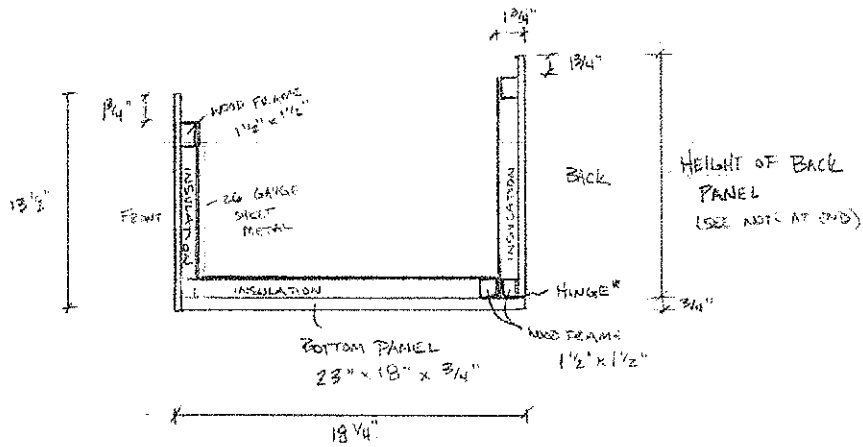

CROSS SECTION THROUGH SIDE

\* THE BACK PANEL WILL BE HINGED TO THE BOTTOM PANEL. ALL THREE REMAINING SIDES WILL BE PERMANENTLY AND RIGIDLY ATTACHED TO ONE ANOTHER AND ATTACHED TO THE BOTTOM PANEL.

11/22/04

2

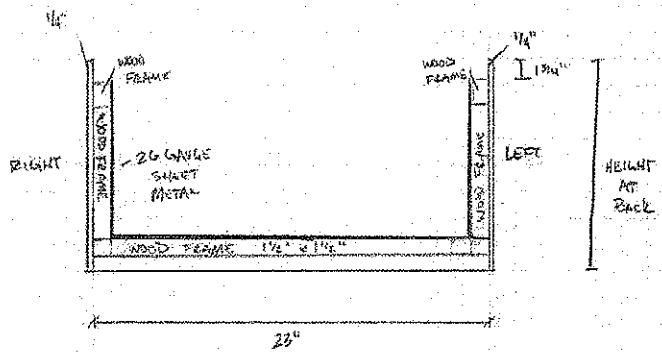

CROSS SECTION AT BACK OF BOX

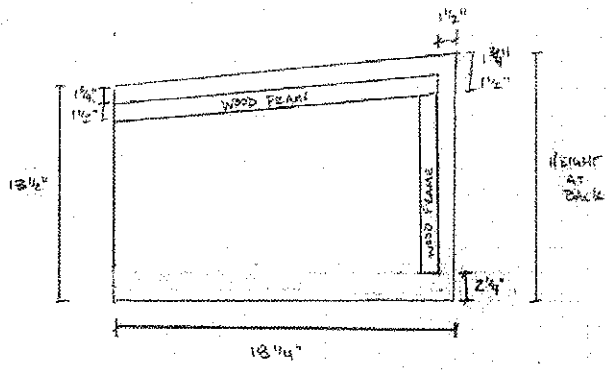

LEFT SIDE PANEL #

\* RIGHT SIDE PANEL IS IDENTICAL DIMENSIONALLY  
ONLY OPPOSITE SIDE GETS WOOD FRAMING

11/22/04

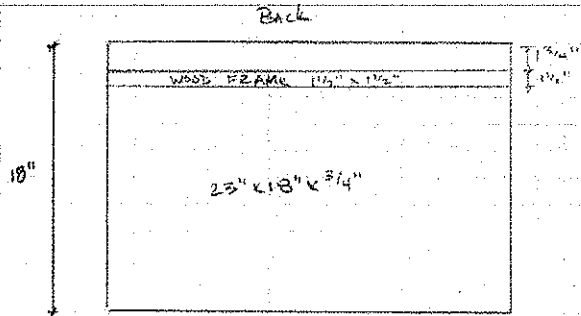

FRONT

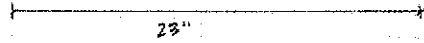

BOTTOM PANEL

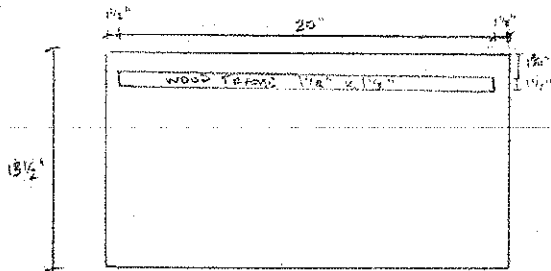

FRONT PANEL

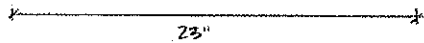

11/22/04

9

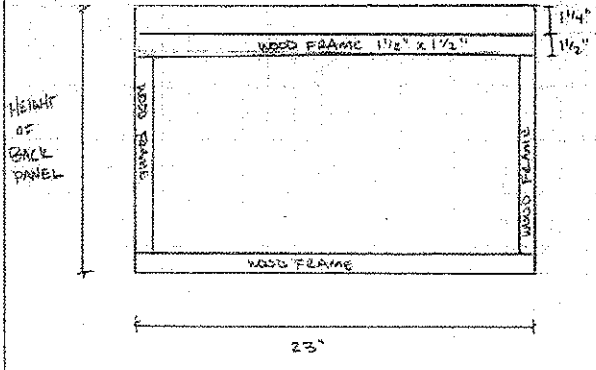

BACK PANEL

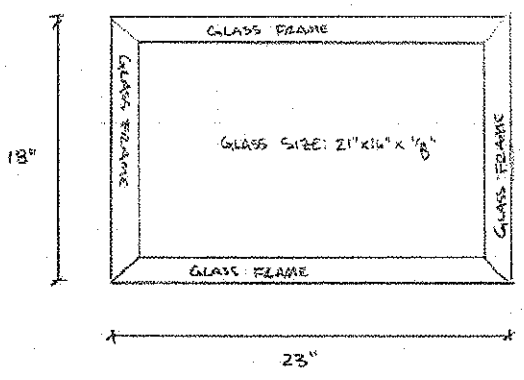

GLASS TOP PLAN

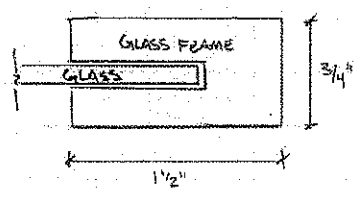

11/22/04

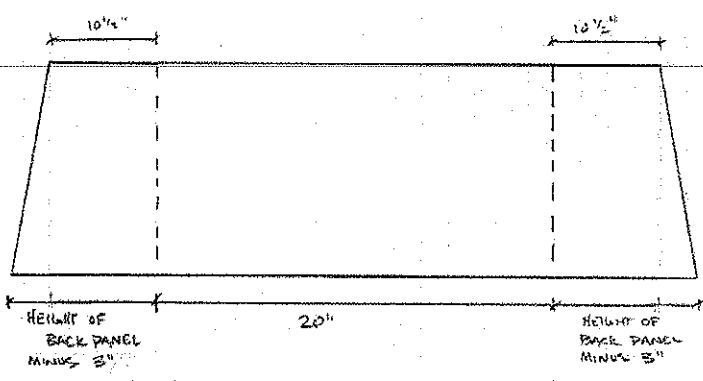

BOTTOM AND SIDE PANEL SHEET METAL

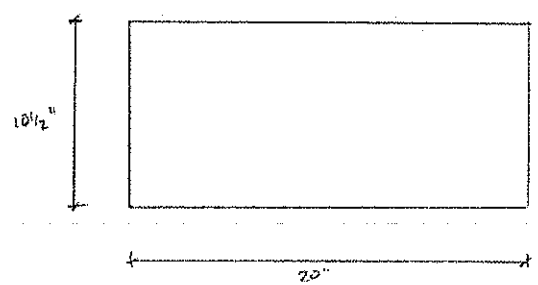

FRONT PANEL SHEET METAL

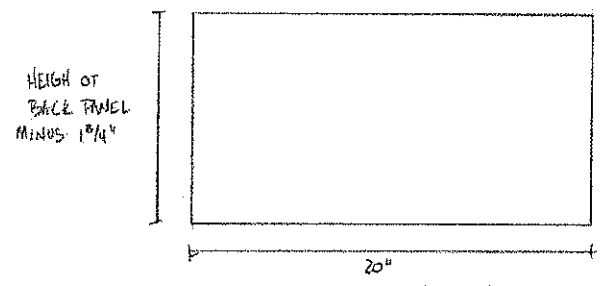

BACK PANEL SHEET METAL

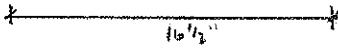
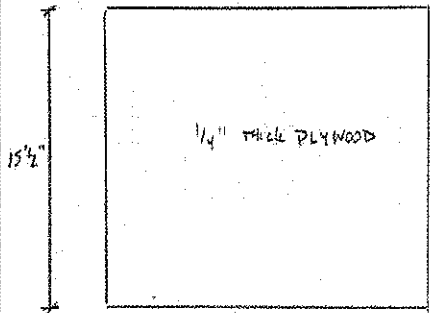

RIGHT REFLECTOR PANEL

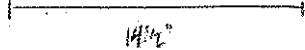
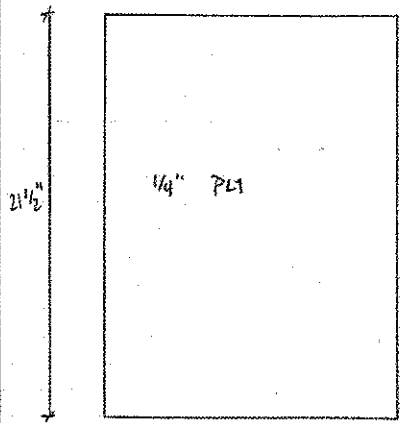

FRONT REFLECTOR PANEL



11/27/04

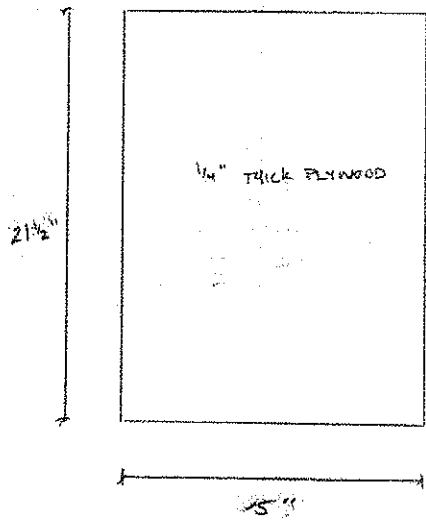

BACK REFLECTOR PANEL

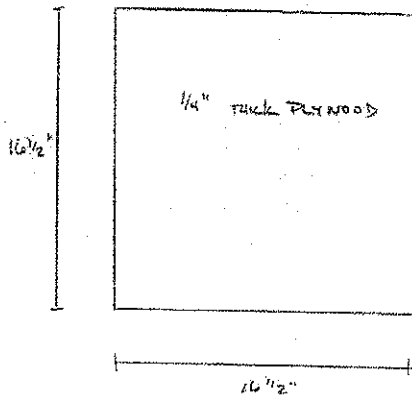

LEFT REFLECTOR PANEL

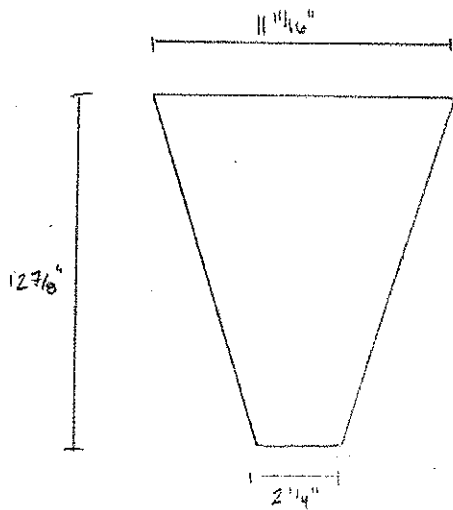

TRAPEZOID PANELS QNT 4

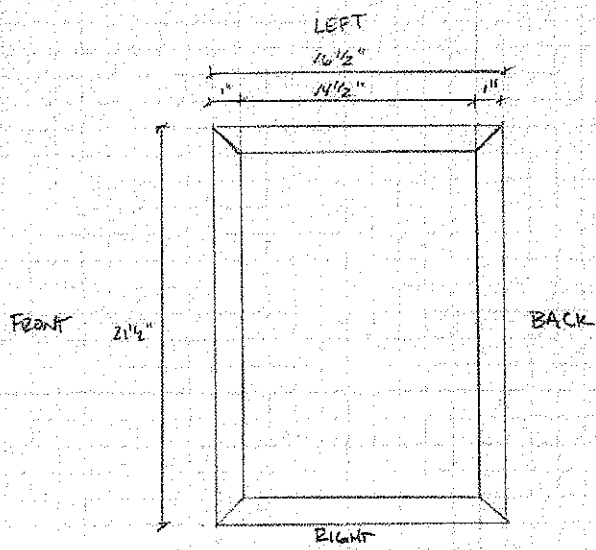

DIMENSIONS

REFLECTOR FRAME

FRONT 21 1/2" x 1" x 3"

BACK 21 1/2" x 1" x 2 1/2"

LEFT 10 1/2" x 1" x 1"

RIGHT 16 1/2" x 1" x 2 1/2"

\* BOTH SIDE PANELS WILL HAVE THE TRAPEZOIDAL PANELS PERMANENTLY ATTACHED WITH HINGES, AND ALL PANELS WILL BE PERMANENTLY ATTACHED TO THE REFLECTOR FRAME WITH HINGES.

WHEN THE REFLECTOR NEEDS TO BE USED THE PANELS THAT ARE NOT PERMANENTLY ATTACHED TO ONE ANOTHER WILL BE TEMPORARILY ATTACHED WITH SOME TYPE OF HARDWARE IN ORDER TO ENSURE RIGIDITY.

THE REFLECTOR FRAME WILL SIT ON TOP OF THE GLASS FRAME AND WILL HAVE HOLES IN LINE WITH HOLES IN THE SIDE FRONT AND BACK PANELS SO THAT BOLTS MAY BE USED TO ATTACH THE REFLECTOR TO THE OVEN.

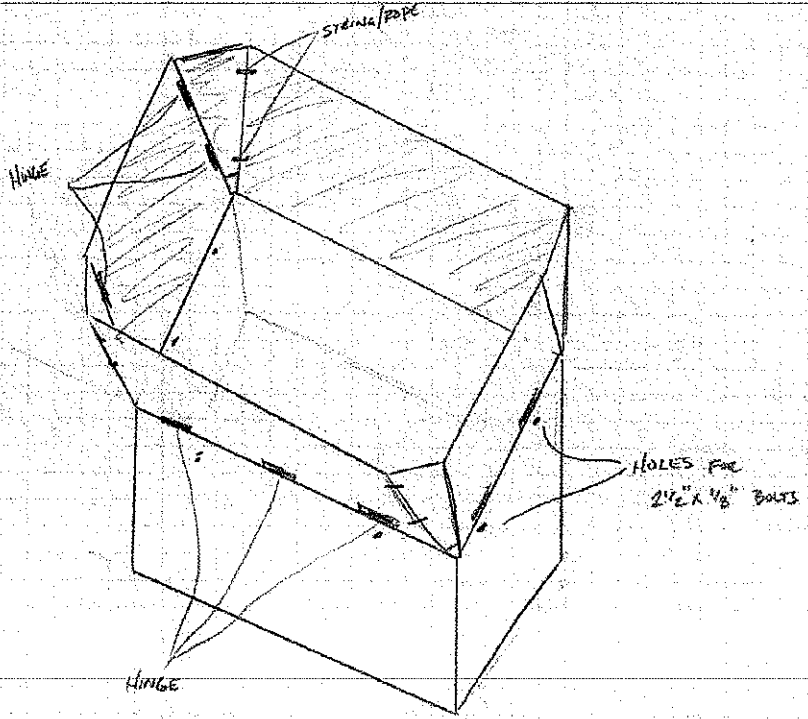

11/22/04

10

HEIGHT OF BACK PANEL:

THE HEIGHT OF THE BACK PANEL WILL BE DEFINED BASED ON THE OPTIMUM ANGLE OF THE REFLECTOR PANELS FOR THE REGION AS WELL AS THE RECOMMENDED MINIMUM HEIGHT OF THE FRONT PANEL (13 1/2").

REMEMBER TO SUBTRACT OUT 3/4" FOR THE THICKNESS OF THE BOTTOM PANEL WHEN CALCULATING THE HEIGHT OF THE BACK PANEL. THIS IS BECAUSE THE BACK PANEL SITS ON THE BOTTOM PANEL.