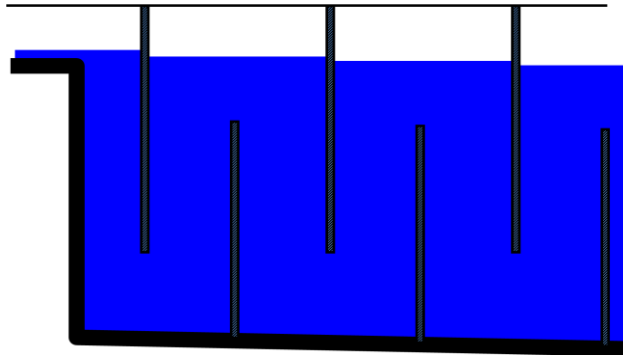


# Travis Stanislaus, tms52, MAE 4291 Senior Design Report

## Abstract:

The total efficiency of  $H/S = 10$  is 0.855 and  $H/S = 4$  is 0.95 for AguaClara flocculation. The flocculation efficiency can be increased by placing obstructions in the flocculator, but the residence time of flocculation is decreased. Flocculation efficiency and residence time efficiency create the total efficiency of a flocculator with obstructions. 2D analysis using  $H/S = 10$  flocculator obstruction configurations simulated in ANSYS Fluent yielded configuration (2), given in section , with total efficiency = 0.906. Standard flocculators can be improved by adding obstructions and decreasing the residence time. More work is needed to evaluate optimization of this optimal configuration.



Flocculator (Courtesy of Professor Monroe Weber-Shirk)

## Table of Contents

Introduction	4
Flocculation	5
Design Statement	13
Simulation and Results	13
Configurations for Flocculator Obstructions	14
2D Flocculator Simulation	21
Results	26
Design and Conclusion	29
Design Recommendations	29
Conclusion	31
Performance Parameter Appendix	32
Configuration Appendix	33
AguaClara Water Treatment Appendix	45
Flocculator Obstruction Design Drawing Appendix	50
User Defined Function Appendix	51
References	53
Senior Design Report Cover Sheet	54

## Terms

$\varepsilon$  = Turbulent Kinetic Energy Dissipation

Q = Flow rate

$\theta$  = Residence time in Flocculator

$\nabla$  = Area

Re = Reynold's Number

$C_D$  = Coefficient of drag

$\alpha_\psi$  = Flocculation efficiency

$\alpha_\theta$  = Residence efficiency

$\alpha_{Total}$  = Total flocculation efficiency

H = Height between Flocculator base and water surface

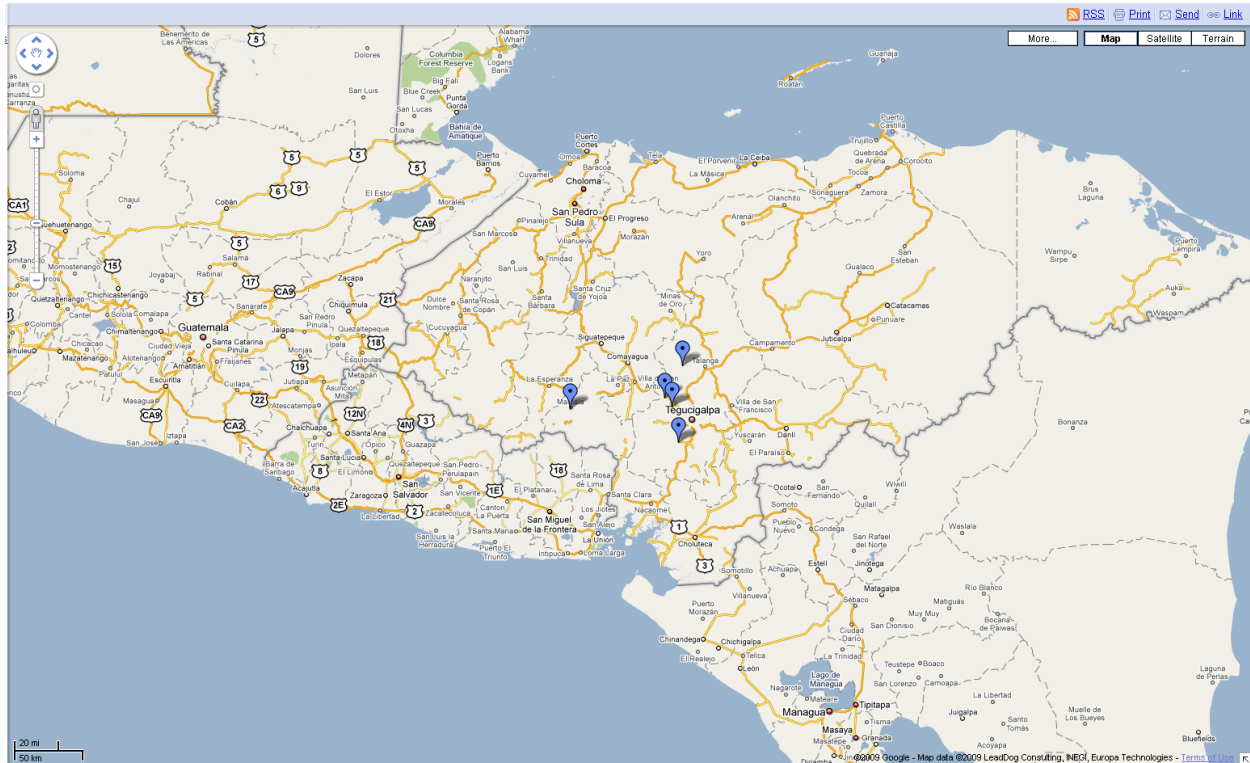
S = Space between the surfaces of baffles

$D_h$  = Hydraulic diameter

Floc = A collection of particles in flocculator created after the turns around the baffles.

# 1. Introduction

AguaClara is a water treatment project in the School of Civil and Environmental Engineering at Cornell University. The director of the project is Professor Monroe Weber-Shirk and the partner for AguaClara is the NGO Agua Para Pueblo, based in Tegucigalpa, Honduras. Students conduct research on AguaClara technology each semester at Cornell University. Amidst the research, AguaClara designs water treatment plants for communities in Honduras, shown in figure 1, and has them constructed. This technology currently provides treated sanitized water for these towns consisting of about 2000 people each.



**Figure 1:** Locations of AguaClara water treatment plants in Honduras

AguaClara treats turbid water, organic particulates and dirt in river water for example, to remove turbidity to enhance chlorine treatment of water. AguaClara uses hydraulic flocculation to treat turbid water. AguaClara water treatment plants have four sections, entrance tank and rapid mixer, flocculator, inlet channel, and sedimentation tank. Aluminum sulfate is added to the incoming water in the entrance tank and rapid mixer. The turbid particles in the water have negative charges, causing them to repel one another and remain suspended in the water. Aluminum sulfate neutralizes the charges and allows the particles to stick together when they collide. The water mixed with aluminum sulfate enters the flocculator where the water flows around baffles and the particulates collide to create flocs. The flocs grow in size until the end of the flocculator. Then the water and flocs enter the inlet channel to the sedimentation tank. The water sits in the sedimentation tank and the flocs settle toward the bottom of the tank, forming a floc blanket. The floc blanket is some distance below the surface and

clean water sits above the blanket. The water is drawn from the top of the sedimentation tank for distribution. The floc blanket becomes dense and even acts as a filter for small particulates.

See **AguaClara Water Treatment Appendix** for visualizations of an AguaClara water treatment plant and components discussed in the **Introduction**.

## 2. Flocculation

AguaClara's project team at Cornell University has a research team divided into sub-teams. Examples of research sub-teams are, chemical dose control, plate settler spacing, rapid mix, flocculation blanket, tube flocculation, and computational fluid dynamics (CFD).

This design study is in CFD research for AguaClara. CFD is used to model the flocculator in AguaClara water treatment. The goal of flocculation is collisions of particulates to build flocs. The pressure drop coefficient around the turn of a baffle,  $K_{Baffle}$ , given by:

$$K_{Baffle} = \frac{1}{Q} \sum \frac{\varepsilon_{cell} \theta_{cell}}{g} \frac{2g}{V^2} Q_{cell} \quad [1]$$

Where  $Q$  is the flow rate into the flocculator given by the width times velocity,  $\varepsilon_{cell}$  is the turbulent kinetic energy dissipation in the cell,  $g$  is gravity,  $V$  is the velocity at the flocculator inlet, and  $\theta_{cell}$  is the residence time in a finite element mesh cell given by:

$$\theta_{cell} = \frac{\forall_{cell}}{Q_{cell}} = \frac{\Delta x \Delta y}{|v_x \Delta x| + |v_y \Delta y|} \quad [2]$$

$\forall_{cell}$  is the cell area and  $Q_{cell}$  is the flow rate through the cell.

The flow weighted average in the flocculator is:

$$\theta_{Baffle} \varepsilon^{1/3} = \frac{1}{Q} \sum \theta_{cell} \varepsilon_{cell}^{1/3} Q_{cell} = \frac{1}{Q} \sum \forall_{cell} \varepsilon_{cell}^{1/3} \quad [3]$$

$\theta_{Baffle}$  is the residence time of fluid in the flocculator. This characterizes the collision potential in the flocculator along with the similar relationships:

$$\theta_{Baffle} \varepsilon^{1/2} = \frac{1}{Q} \sum \forall_{cell} \varepsilon_{cell}^{1/2} \quad [4],$$

and

$$\theta_{Baffle} \varepsilon = \frac{1}{Q} \sum \forall_{cell} \varepsilon_{cell} = \frac{A}{Q} \varepsilon_{floculator} \quad [5]$$

The energy dissipation in the flocculator allows flocs to build in size and flocs are larger further in the flocculator. Large flocs break into smaller flocs when the turbulent kinetic energy dissipation is too high and small flocs rise above the floc blanket in the sedimentation tank where turbidity treated water is

drawn for chlorine treatment. The dynamics of floc particles are investigated by Professor Monroe Weber-Shirk in his flocculation powerpoint presentation for CEE 4540. The floc is modeled as a sphere and the strength of a large floc is assessed at the end of a flocculator. The strength of the floc is:

$$\tau_{floc} \approx \frac{C_D \rho_{water} \varepsilon d_{floc}^2}{32\nu} \quad [6]$$

The Reynolds number of the floc is:

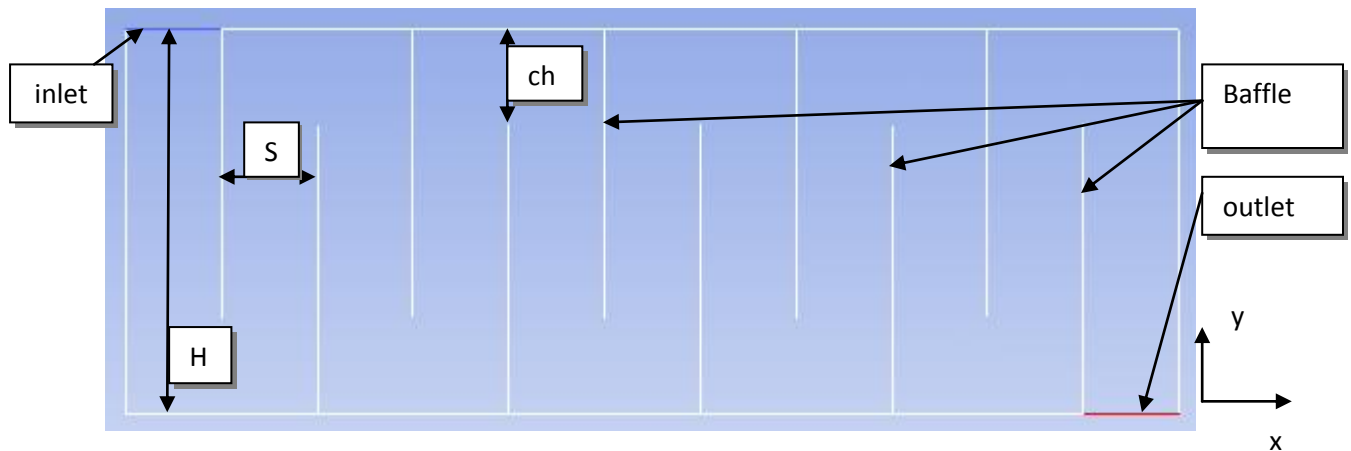
$$Re = \left( \sqrt{\frac{\varepsilon d}{\nu}} \right) \frac{d}{\nu} \quad [7]$$

The diameter of the floc,  $d$  is chosen as 5 mm, from reference  $\varepsilon = 0.4 \frac{mW}{kg}$ , and  $\nu$  is the viscosity of water.  $Re \approx 125$  and the drag on the floc is:

$$C_D = \frac{24}{Re} + \frac{3}{\sqrt{Re}} + 0.34 \quad [8]$$

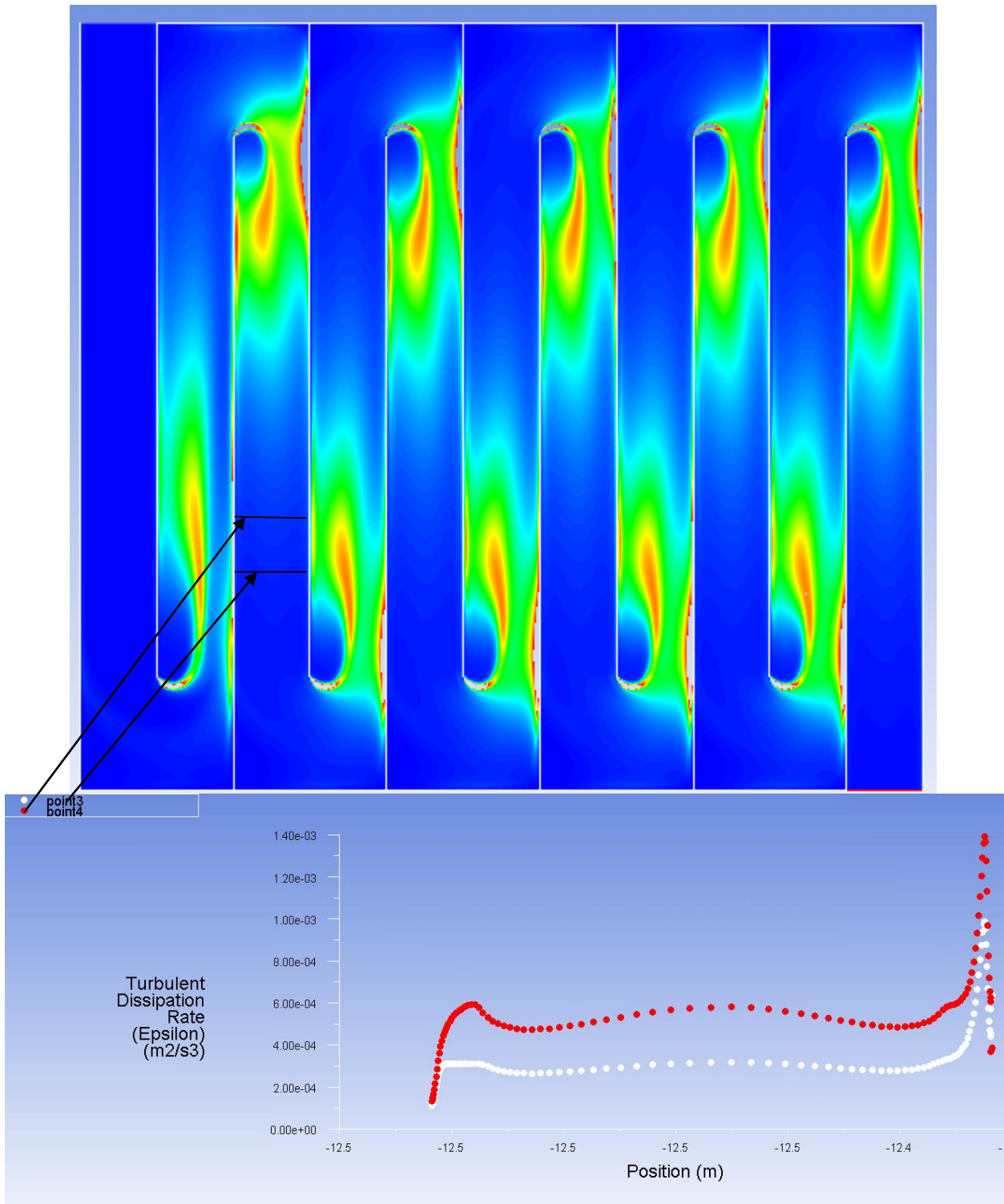
giving  $C_D \approx 0.8$ . In this example by Professor Monroe Weber-Shirk for a floc the end of the flocculator,  $\tau_{floc} \approx 0.25 Pa$ .

The regions of high turbulent kinetic energy dissipation are after the turns of the baffles in the flocculator, shown in **Figure 3**, and the flocculator has  $N$  turns to achieve proper floc size for sedimentation.

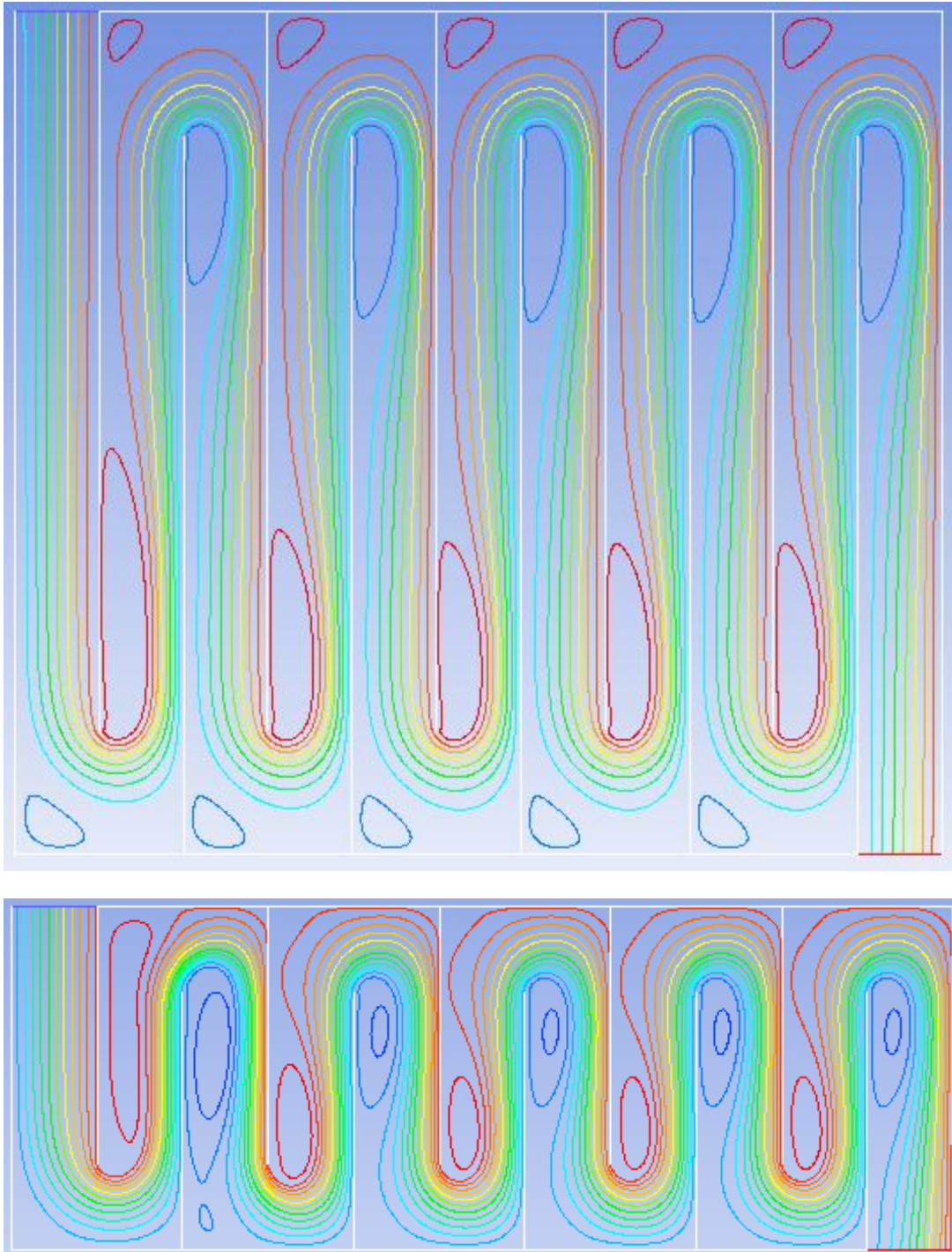


**Figure 2:** Standard flocculator dimensions and direction of flow

The flocculator has areas of low turbulent kinetic energy dissipation after the baffle turns or dead zones for flocculation where limited collisions occur, shown in **Figure 3**.  $H/S$  is the ratio of the height of the water in the flocculator and the spacing between the surfaces of the baffle.



The H/S ratio determines characteristics of the water flow in the flocculator which in turn determines flocculation performance.

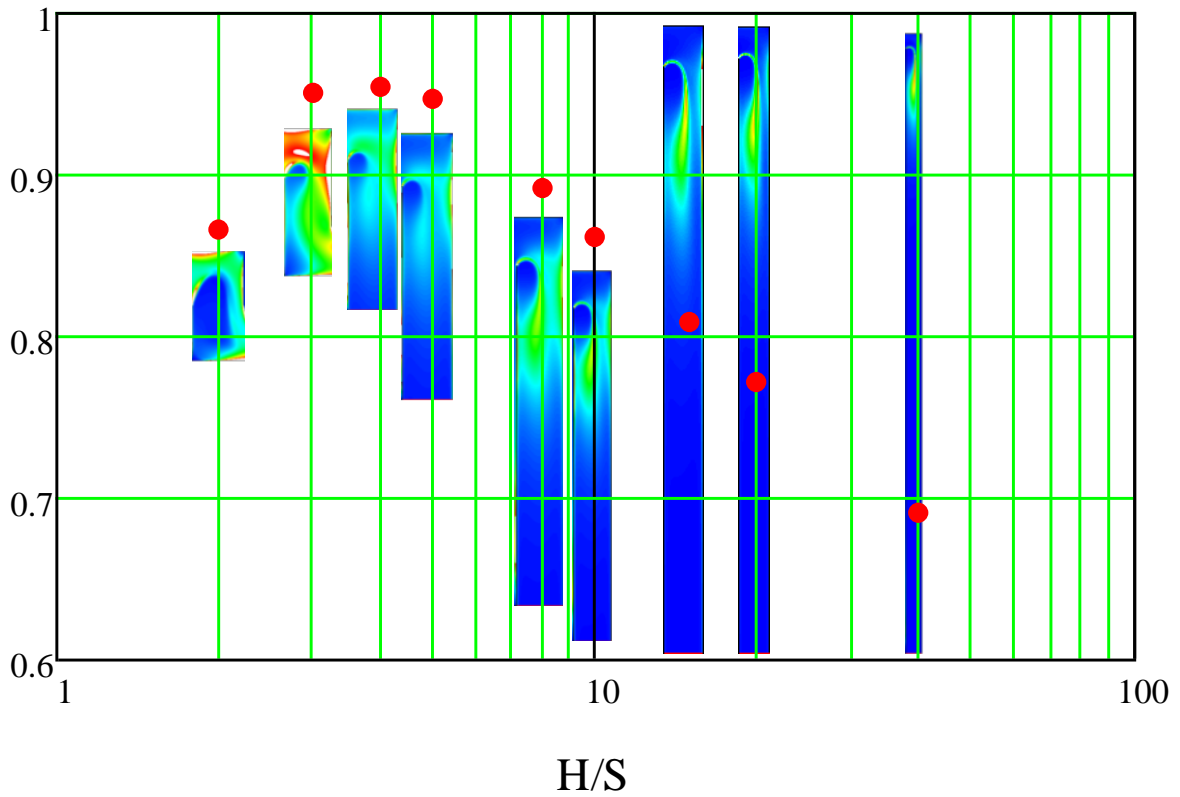


**Figure 4:** Stream function of  $H/S = 10$  and  $H/S = 4$

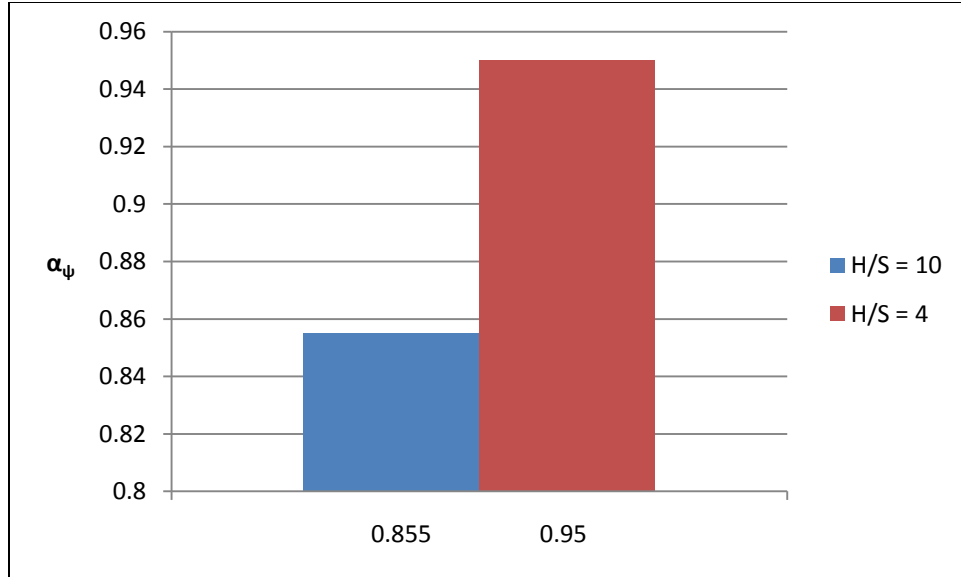


Previous H/S investigation by AguaClara concluded that H/S = 4 is the optimal flocculator configuration for flocculation performance. The flocculation efficiency is:

$$\alpha_\psi = \frac{\int_V \varepsilon^{1/3} dV}{(\nabla^2 \int_V \varepsilon dV)^{1/3}} \quad [9]$$



**Figure 5:** Flocculation efficiency of standard H/S flocculator configurations. (Courtesy of Professor Monroe Weber-Shirk)



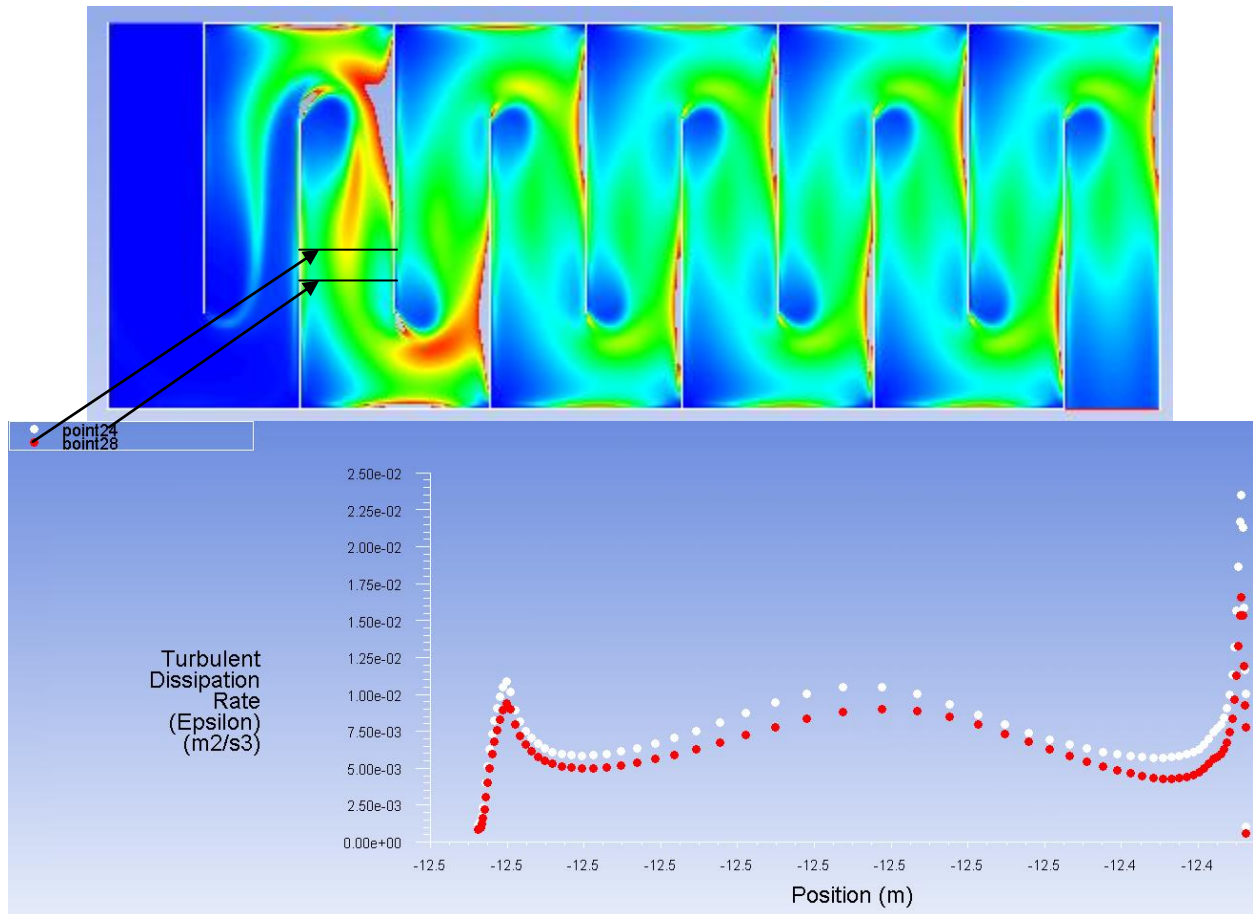
**Figure 6:** Flocculation efficiency of H/S = 10 and H/S = 4

When a standard H/S geometry is adjusted by keeping H/S constant while blocking space in the flocculator to reduce the area of the flocculator, residence time efficiency is instituted. The residence time efficiency,  $\alpha_\theta$ , takes into account the reduction in flocculation performance the decrease in area causes. The performance is reduced by decreasing the area because the residence time in the flocculator is reduced by decreasing the area causing collision potential, [3], to decrease. Residence time efficiency is:

$$\alpha_\theta = \frac{\text{reduced Area}}{\text{original Area}} \quad [10]$$

Combining [9] and [10] gives the total efficiency of the flocculator which takes into account efficiency of energy dissipation and efficiency of residence time in the flocculator.

$$\alpha_{Total} = \alpha_\psi * \alpha_\theta \quad [11]$$



**Figure 7:** Standard  $H/S = 4 \varepsilon$  profile and  $\varepsilon$  away from the baffle turn

The collision time for flocs is:

$$t_c = \frac{1}{6} \left( \frac{6}{\pi} \right)^{1/9} \left( \frac{d_{floc}^2}{\varepsilon} \right) \frac{1}{\phi_{floc}^{8/9}} \quad [12]$$

where  $\phi_{floc}$  is the ratio of floc volume to suspension volume. The collision time expresses effect the turbulent energy dissipation has for flocculation. The collision time of flocs is related to the total length of flocculation.

The structure of the entire water treatment limits the dimensions of the flocculator in the treatment plant. Professor Weber-Shirk states, the water depth in a vertical flocculator is determined by the depth of the sedimentation tank. He also states, the width of the flocculator channel must be at least 45 cm because people need to fit in the channel during construction of the flocculator and the baffles will be placed closer together because of the width of the channel, resulting in a higher  $H/S$ . Construction cost constrains the length and depth of the flocculator and sedimentation tank to be the same. See **Agua Clara Water Treatment Appendix** for images of the flocculator and sedimentation tank.

The constraints mean the flocculator in the AguaClara plant is built with a less than optimal H/S ratio for flocculation. S is given by:

$$S = \frac{Q}{W} \left( \frac{\alpha_\varepsilon K_p}{2\varepsilon_{max}H} \right)^{1/3} \quad [13]$$

$K_p$  is the pressure drop coefficient between baffles and  $\alpha_\varepsilon$  is the ratio of  $\varepsilon_{max}$  the flocculator is designed for and  $\varepsilon_{Headloss}$ . For example, holding the H fixed so it matches the sedimentation tank depth, S needs to be increased to change H/S = 10 to H/S = 4. However, W must be decreased to increase S and W is bounded at a minimum of 45 cm.

$K_p$  is equivalent to  $C_p$ , the coefficient of pressure.

$$C_p = \frac{p - p_o}{\frac{1}{2}\rho V^2} \quad [14]$$

$C_p$  can be compared among different cases and capture trends in case behaviors since it is a dimensionless parameter.

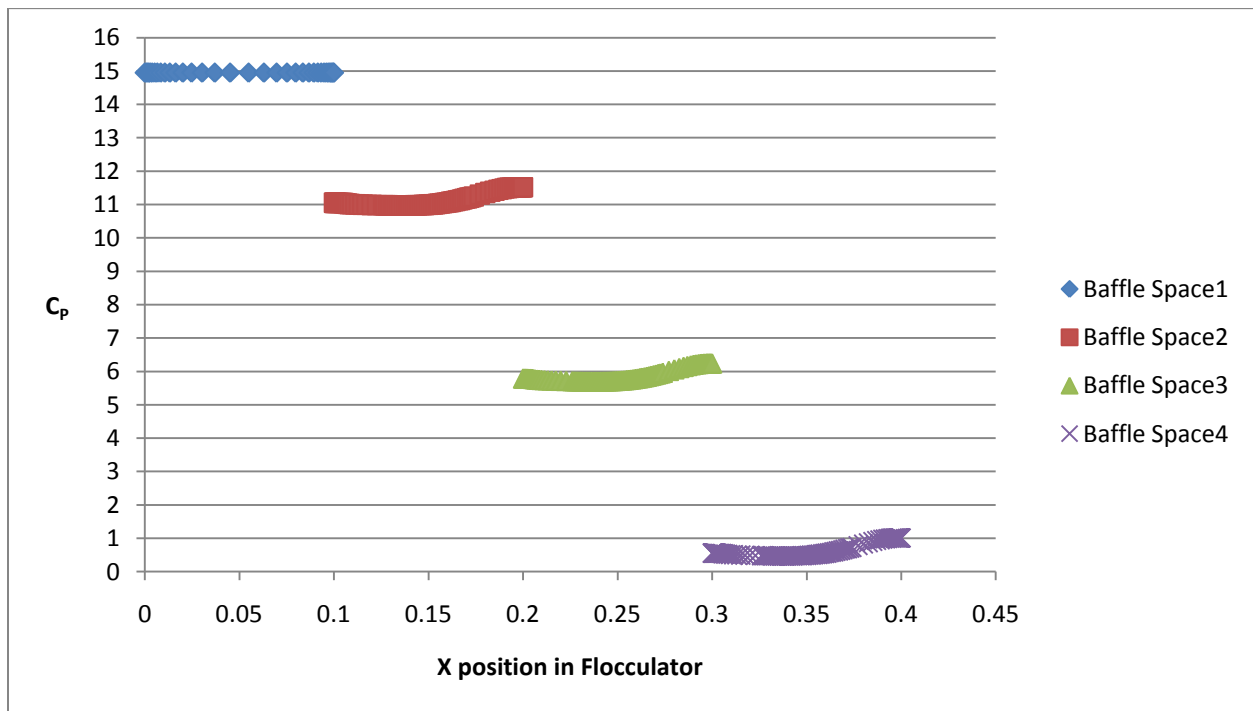
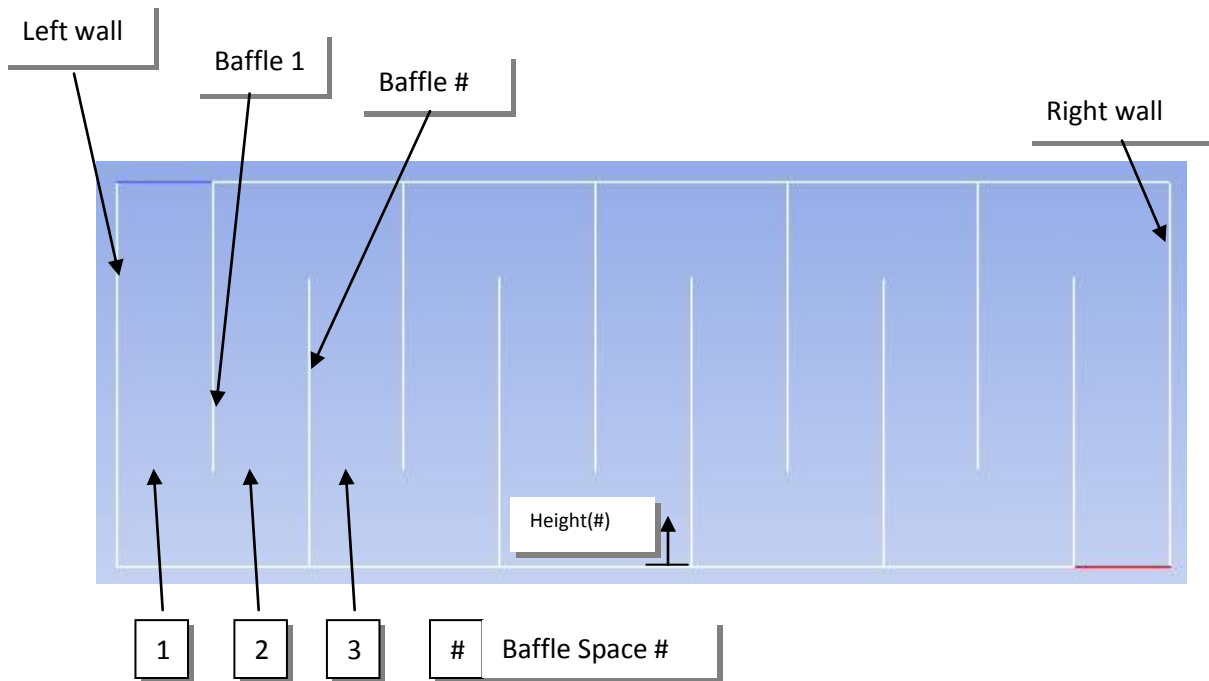


Figure 8:  $C_p$  drop after turns around baffles

### 3. Design Statement

The flocculators in AguaClara plants are constrained to be built at higher than optimal H/S ratios. High H/S flocculators have deadzones in the flocculation as opposed to lower H/S flocculators, shown by **Figure 3** and **Figure 7**. The goal of this design investigation is to use placement of obstructions in the flocculator to increase flocculation efficiency, decreasing dead zones, while keeping H/S fixed at 10 with  $H = 1\text{ m}$ ,  $S = .1\text{ m}$ , and  $ch = .15\text{ m}$ , and keeping flocculator  $\varepsilon$  below  $5 \times 10^{-3} \frac{m^2}{s^3}$ .

### 4. Simulation and Results

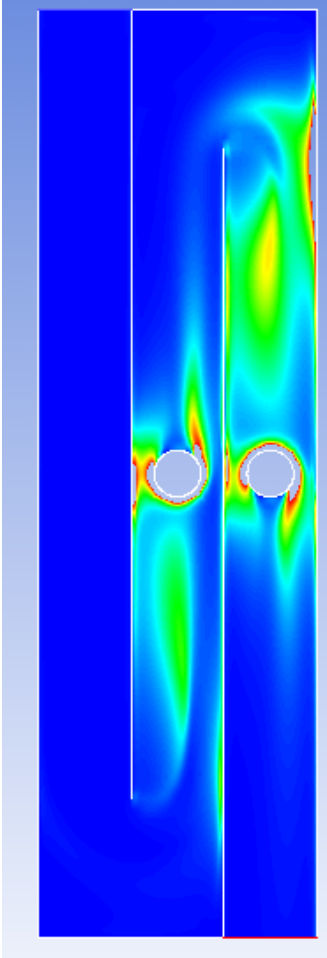


**Figure 9:** Conventions for flocculator configuration table

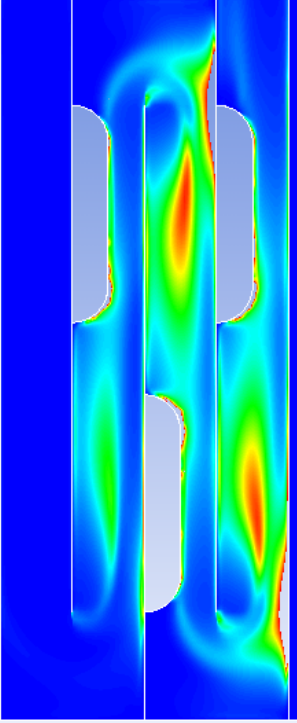
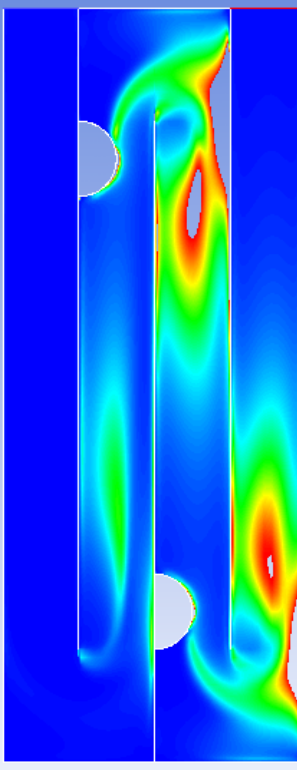
#### 4.I Configurations for Flocculator Obstructions

Flocculator dimensions: H = 1 m, S = 0.1 m

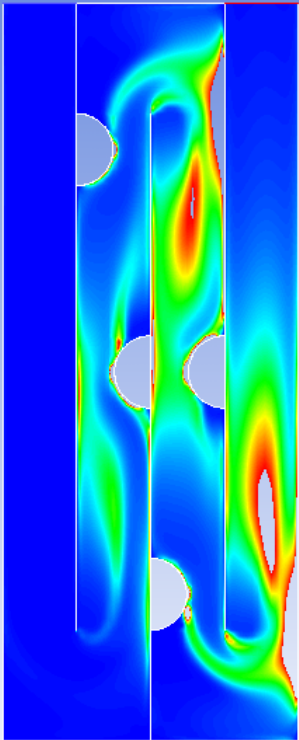
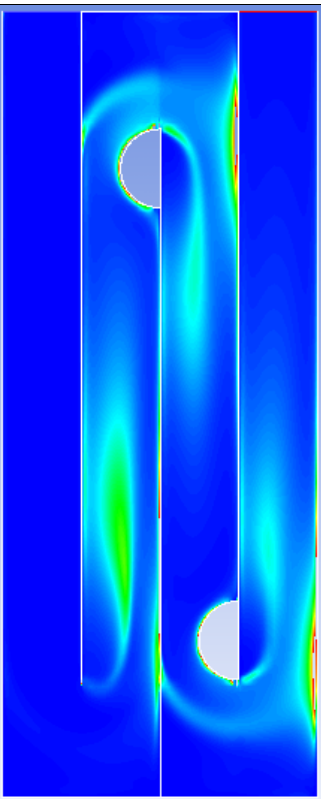
[note: Height(shape#) is distance from the bottom surface to the center of the shape]

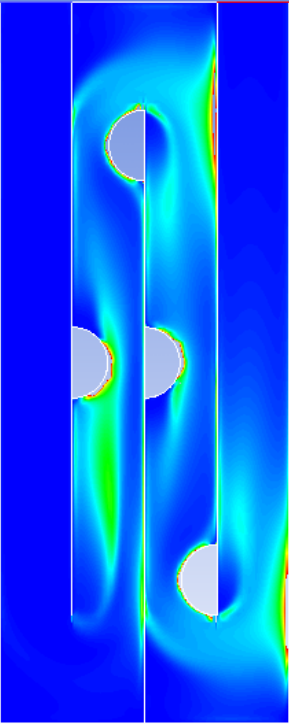
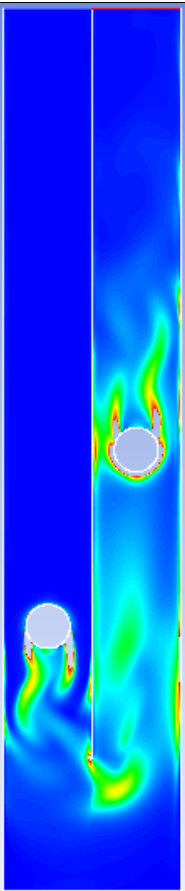
Reference Number	Configuration	Dimensions	Position
 <p>(1)</p>	<p><b>Baffle Space 2:</b> One circle</p> <p><b>Baffle Space 3:</b> One circle</p>	<p>Diameter(all) = 5 cm</p> <p>Two turns</p>	<p>Height = 50 cm</p> <p>Center Position = 0.5*S</p>

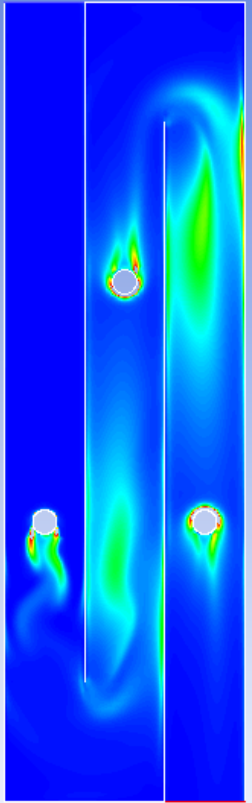
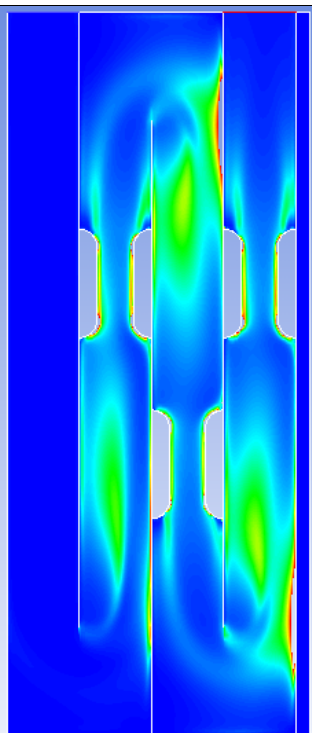
<p>(2)</p>		<p><b>Baffle 1:</b> Half circle1</p> <p><b>Baffle 2:</b> Half circle2, Half circle3</p> <p><b>Baffle 3:</b> Half circle4, Half circle5</p> <p><b>Right Wall:</b> Half circle6</p>	<p>Radius(all)= 2.5 cm</p> <p>Three turns</p>	<p><b>Baffle 1:</b> Height(1) = 55 cm</p> <p><b>Baffle 2:</b> Height(2) = 55 cm Height(3) = 45 cm</p> <p><b>Baffle 3:</b> Height(4) = 45 cm Height(5) = 55 cm</p> <p><b>Right Wall:</b> Height(6) = 55 cm</p>
<p>(3)</p>		<p><b>Baffle 1:</b> Half oval1</p> <p><b>Baffle 2:</b> ,Half oval2. Half oval3</p> <p><b>Baffle 3:</b> Half oval4, Half oval5</p> <p><b>Right Wall:</b> Half oval6</p>	<p>Radius(all) = 2.5 cm</p> <p>Total Length(all) = 30 cm</p> <p>Three turns</p>	<p><b>Baffle 1:</b> Height(1) = 70 cm</p> <p><b>Baffle 2:</b> Height(2) = 70 cm Height(3) = 30 cm</p> <p><b>Baffle 3:</b> Height(4) = 30 cm Height(5) = 70 cm</p> <p><b>Right Wall:</b> Height(6) = 70 cm</p>

<p>(4)</p>		<p><b>Baffle 1:</b> Half oval1  <b>Baffle 2:</b> Half oval2  <b>Baffle 3:</b> Half oval3</p>	<p>Radius(all) = 5 cm  Total Length(all) = 30 cm</p>	<p><b>Baffle 1:</b>  Height(1) = 70 cm  <b>Baffle2:</b>  Height(2) = 30 cm  <b>Baffle 3:</b>  Height(3) = 70 cm</p>
<p>(5)</p>		<p><b>Baffle 1:</b> Half circle1  <b>Baffle 2:</b> Half circle2</p>	<p>Radius(all) = 5 cm  Three turns</p>	<p><b>Baffle 1</b>  Height(1)= 80 cm  <b>Baffle 2</b>  Height(2) = 20 cm</p>

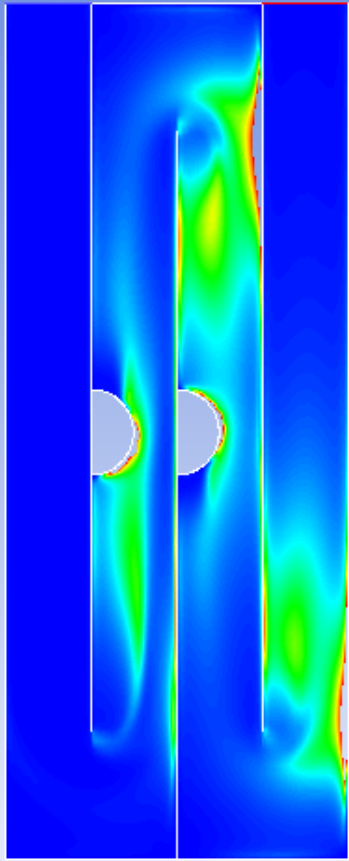


<p>(6)</p>		<p><b>Baffle 1:</b> Half circle1</p> <p><b>Baffle 2:</b> Half circle2, Half circle3</p> <p><b>Baffle 3:</b> Half circle4</p>	<p>Radius(all) = 5 cm</p> <p>Three turns</p>	<p><b>Baffle 1:</b> Height(1) = 80 cm</p> <p><b>Baffle 2:</b> Height(2) = 50 cm Height(3) = 20 cm</p> <p><b>Baffle 3:</b> Height(4) = 50 cm</p>
<p>(7)</p>		<p><b>Baffle 2:</b> Half circle1</p> <p><b>Baffle 3:</b> Half circle2</p>	<p>Radius(all) = 5 cm</p> <p>Three turns</p>	<p><b>Baffle 2:</b> Height(1) = 80 cm</p> <p><b>Baffle 3:</b> Height(2) = 20 cm</p>

<p>(8)</p>		<p><b>Baffle 1:</b> Half circle1</p> <p><b>Baffle 2:</b> Half circle2, Half circle3</p> <p><b>Baffle 3:</b> Half circle4</p>	<p>Radius(all) = 5 cm</p> <p>Three turns</p>	<p><b>Baffle 1:</b> Height(1) = 50 cm</p> <p><b>Baffle 2:</b> Height(2) = 80 cm Height(3) = 50 cm</p> <p><b>Right Wall:</b> Height(4) = 20 cm</p>
<p>(9)</p>		<p><b>Baffle Space 1:</b> Circle1</p> <p><b>Baffle Space 2:</b> Circle2</p>	<p>Radius(all) = 5 cm</p> <p>One turn</p>	<p>Height(1) = 30 cm Height(2) = 50 cm</p> <p>Center Position =0.5*S</p>

<p>(10)</p>		<p><b>Baffle Space 1:</b> Circle1</p> <p><b>Baffle Space 2:</b> Circle2</p> <p><b>Baffle Space 3:</b> Circle3</p>	<p>Radius = 3 cm</p> <p>Two turns</p>	<p>Height(1) = Height(3) = 35 cm</p> <p>Height(2) = 65 cm</p> <p>Center Position(all) = 0.5*S</p>
<p>(11)</p>		<p><b>Baffle 1:</b> Half oval1</p> <p><b>Baffle 2:</b> ,Half oval2. Half oval3</p> <p><b>Baffle 3:</b> Half oval4Half oval5</p> <p><b>Right Wall:</b> Half oval6</p>	<p>Radius(all) = 2.5 cm</p> <p>Total Length(all) = 15 cm</p> <p>Three turns</p>	<p><b>Baffle 1:</b> Height(1) = 55 cm</p> <p><b>Baffle 2:</b> Height(2) = 55 cm Height(3) = 45 cm</p> <p><b>Baffle 3:</b> Height(4) = 45 cm Height(5) = 55 cm</p> <p><b>Right Wall:</b> Height(6) = 55 cm</p>

(12)



**Baffle 1:** Half circle1

**Baffle 2:** Half circle2

Radius(all) = 5 cm

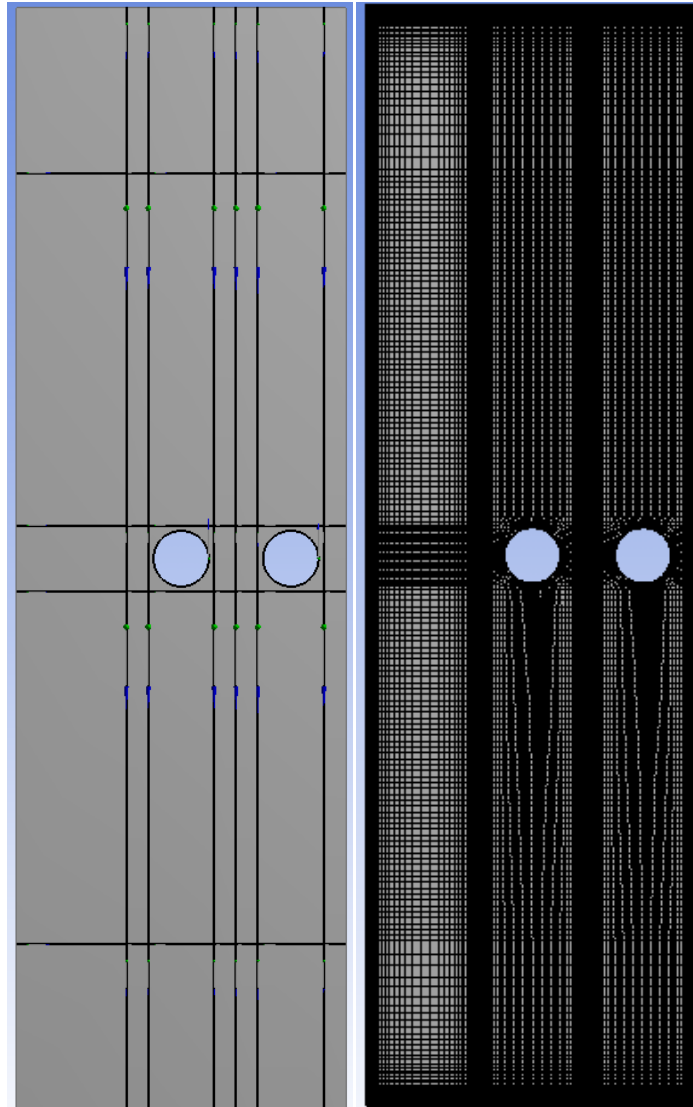
Three turns

**Baffle 1:**  
Height(1) = 50 cm

**Baffle 2:**  
Height(2) = 50 cm

## 4.II 2D Flocculator Simulation

ANSYS Fluent was used to simulate and evaluate the flocculator configurations. Previous AguaClara teams have studied how to correctly model a 2D AguaClara flocculator in Fluent. “CFD Analysis of a Flocculation Tank and Design Recommendations” by Yong Sheng Khoo and Jesse Prager was used to create the correct 2D flocculator simulation in Fluent.



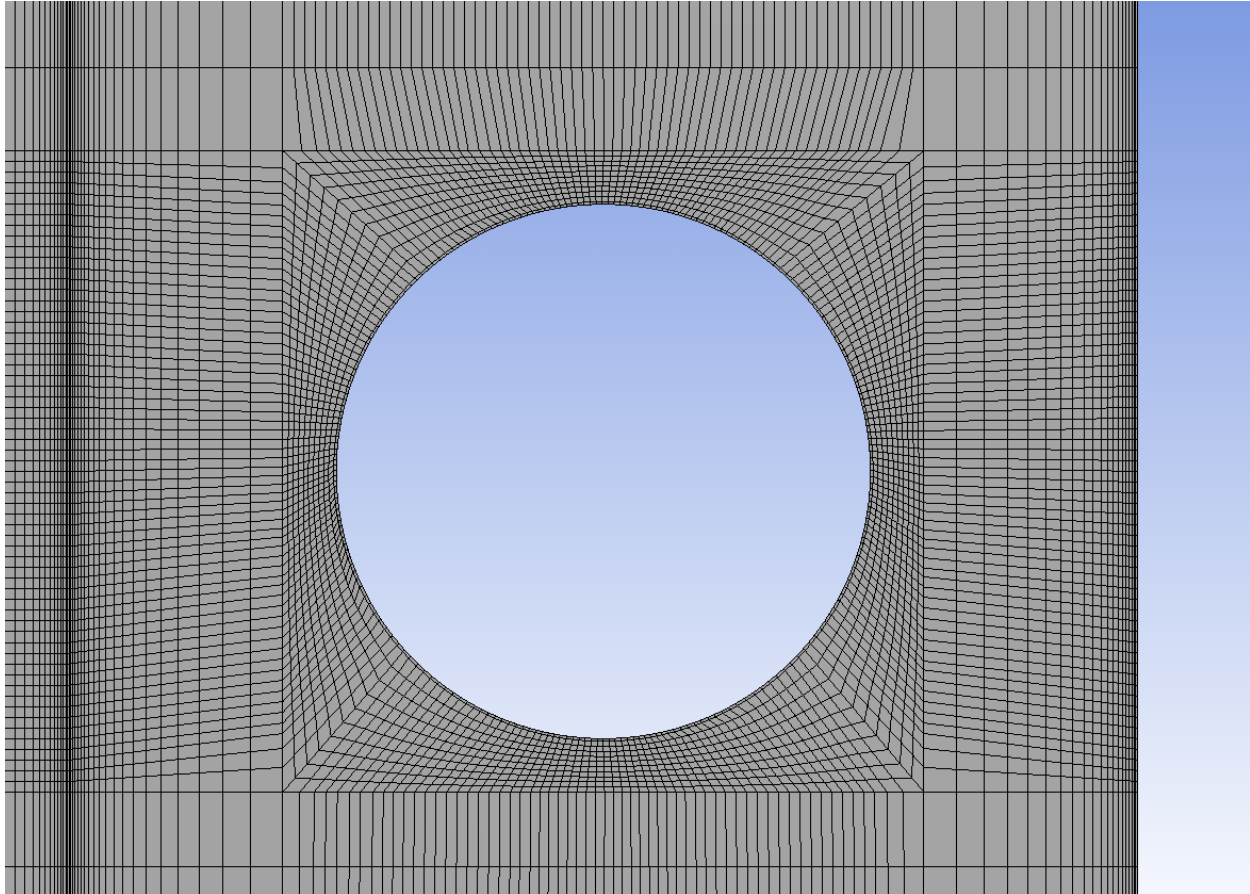
**Figure 10:** Flocculator geometry sketch and mesh

### Geometry Setup

The flocculator is sketched in Fluent as a rectangle with dimensions matching the respective  $H$ ,  $S$  and number of baffle spaces of the flocculator being modeled. The obstructions are cut out of the rectangle and the baffles are drawn as vertical lines the top to the bottom of the rectangle and are spaced at  $S$ . Horizontal lines are drawn from the left to right surface of the rectangle at  $ch$  distance from

the top and bottom of the rectangle. The sketch is partitioned further to allow for accurate cell development around the shapes cutout in the sketch. The baffles and the partitions are defined using the lines from sketches tool and projecting the created lines onto the rectangle.

## Mesh Generation



**Figure 11:** Mesh generation at obstruction in flocculator

The mesh is created using mapped face mesh and dividing the edges of the zones into divisions. The cell size near the four surfaces of the flocculator and the surfaces of the baffle is decreased using the bias tool to get a turbulent a value of  $y^+ < 5$  at the surfaces in the simulation. The baffles, the obstruction surfaces, and the flocculator walls, surface, base, inlet, and outlet are defined for the simulation of water flow in Fluent after generating the mesh.

## Fluent Simulation

The turbulence model for these simulation is  $K\varepsilon$  Realizable, which is the turbulence model specified for AguaClara flocculator simulations after by Yong Sheng Khoo and Jesse Prager in “CFD Analysis of a Flocculation Tank and Design Recommendations”. “CFD Analysis of a Flocculation Tank and Design Recommendations” also specifies the inlet velocity to be set at  $0.1 \text{ m/s}$  for simulations of the

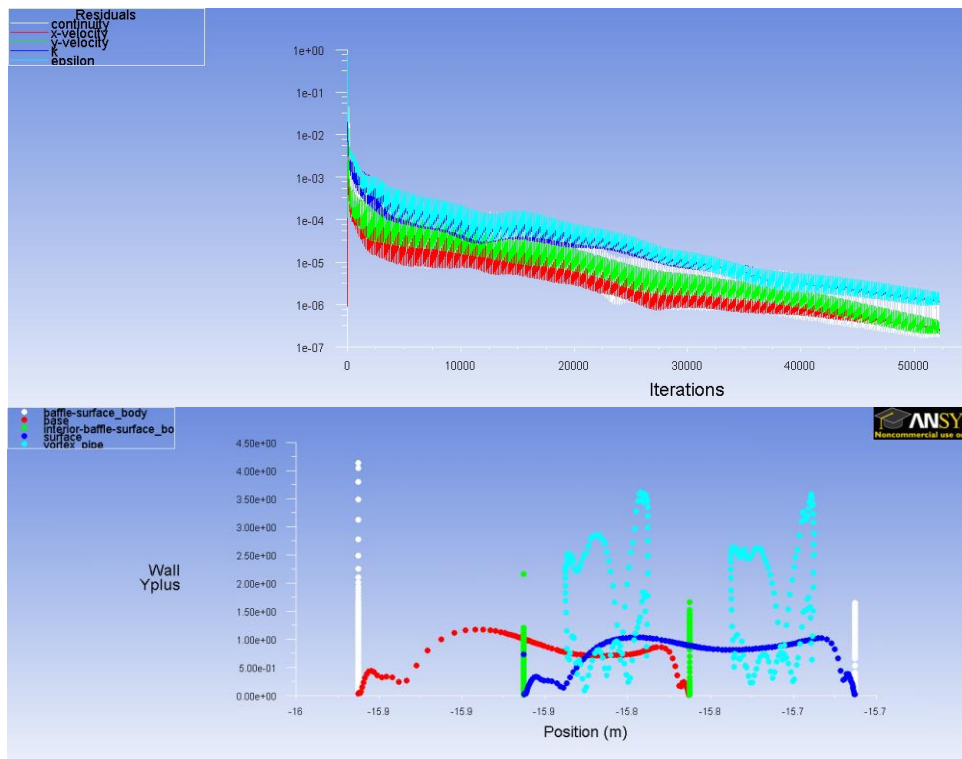
flocculator. The material for the simulation is water, so the density is set to  $1000 \frac{kg}{m^3}$  and the viscosity is  $1.003 * 10^{-3} \frac{kg}{m.s}$ . The appropriate surfaces defined in the mesher are set as walls, inlet, or outlet. Flow rate,  $Q$ , is  $0.01 \frac{m^2}{s}$  since  $S = 0.1$  m and the flocculator is 2D. The inlet in boundary conditions is set for intensity and hydraulic diameter. Turbulent intensity is set to 10% and a hydraulic diameter is:

$$D_h = \frac{4 * Area}{Perimeter} = \frac{2 * L * W}{(L + W)} \quad [15]$$

In these cases the width of the flocculator is assumed at least 45 cm so  $D_h$  is 0.1636 m. Fully turbulent flow enters the flocculator in the AguaClara water treatment plant through offices. Fluent states that turbulent intensity of 10% or greater is turbulent input into the simulation. The reference values are adjusted so  $C_p$  is calculated correctly. The convergence criteria are adjusted to  $1 \times 10^{-6}$ . The simulation is run in transient setting because of varying flow shedding off of the obstructions in the flocculator. The time step size for the flocculator configuration is obtained by:

$$Time \ step \ size = \frac{S}{inlet \ velocity} \quad [16]$$

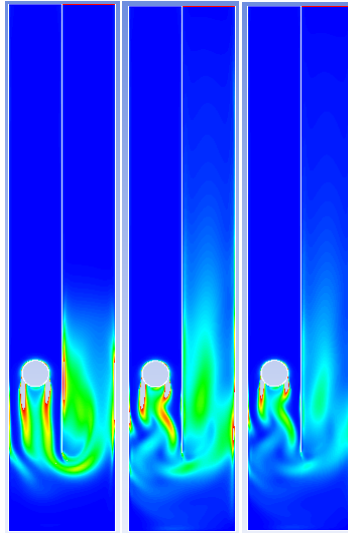
The time step size for this set up is 1 sec and Fluent recommends using a fraction of the time step size in the simulation, so a time step of 0.1 sec is used. The number of time steps gives the time elapsed in the simulation. At least 350 time steps, 35 sec, were used, to allow the fluid flow in the flocculator to develop. Each time step is set to iterate 150 times per step.



**Figure 12:** Convergence of transient simulation to  $1 \times 10^{-6}$  and  $y+ < 5$  at surfaces in simulations

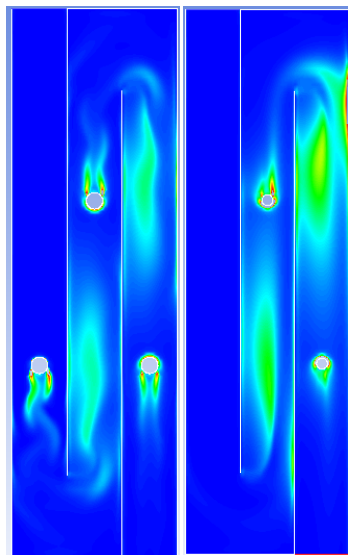
## Transient Analysis

The time varying flow shed from the obstructions disappeared after the flow developed. Early flocculator configurations displayed constant flow shed, which developed in to a repeating pattern of shedding.



**Figure 13:** Time varying turbulent kinetic energy dissipation due to flow shedding

Obstructions were removed from the entrance baffle space in the baffle space because the constant shedding resulted from the constant flow the simulation entered the flocculator. Ideal constant turbulent flow does not enter existing AguaClara flocculators, making the repeating flow shed pattern an inaccurate image of an AguaClara flocculator.



**Figure 14:** Flow shed removed by making the first baffle space unobstructed



## User Defined Functions and Simulation Setup Comparison to Historical Results

Equations [3], [4], and [5] are evaluated for each configuration simulation using user defined functions (udf) developed for Agua Clara by Yong Sheng Khoo, Jesse Prager, and Wenqi Yi, and edited by Steven Southern and Travis Stanislaus. The UDF is available in the **User Defined Function Appendix**.

The simulation setup was analysed for the base H/S = 4 and H/S = 10 and compared to results for the cases obtained by Wenqi Yi to ensure correctness of the geometry, mesh, and simulation setup.

Parameter	H/S = 4				H/S = 10			
	Historical simulation		Current simulation		Historical simulation		Current simulation	
	Baffle Space 2	Baffle Space 3	Baffle Space 2	Baffle Space 3	Baffle Space 2	Baffle Space 3	Baffle Space 2	Baffle Space 3
$\theta_{Baffle} \varepsilon^{1/3} \left[ \frac{m^2}{s} \right]$	4.2E-01	7.8E-01	0.46	0.76	1.0E+00	1.0E+00	0.98	0.996
$\theta_{Baffle} \varepsilon^{1/2} \left[ \frac{m}{s^{1/3}} \right]$	1.5E-01	3.6E-01	0.16	0.34	3.5E-01	3.4E-01	0.32	0.34
$\theta_{Baffle} \varepsilon \left[ \frac{m^2}{s^2} \right]$	8.0E-03	3.7E-02	0.0085	0.032	1.6E-02	1.7E-02	0.013	0.016

**Table 1:** Comparison of historical flocculator simulations and current simulations

### 4.III Results

The flocculation efficiencies, [9], [10], and [11], and coefficient of pressure were evaluated for each flocculator obstruction configuration.

Reference Number	$\alpha_{\psi}$	Area Between Baffles [ $m^2$ ]	$\alpha_{\theta}$	$\alpha_{Total} = \alpha_{\psi} * \alpha_{\theta}$	$C_p$
H/S = 10	0.855	0.1	1	.0855	4
(1)	0.854	0.098243	0.982	0.839	5.96
(2)	0.918	0.098762	0.988	0.906	3.84
(3)	0.881	0.085634	0.856	0.754	5.3
(4)	0.887	0.086504	0.865	0.768	6.4
(5)	0.867	0.096625	0.966	0.838	7.6
(6)	0.88	0.09254	0.925	0.814	8.53
(7)	0.897	0.096625	0.966	0.867	2.74
(8)	0.933	0.092699	0.927	0.866	2.2
(9)	0.887	0.098187	0.982	0.871	5.5
(10)	0.901	0.099441	0.994	0.896	3.78
(11)	0.919	0.093873	0.939	0.863	4.5
(12)	0.903	0.096708	.967	0.874	3.67

**Table 2:** Efficiency and Pressure Coefficient of each flocculator configuration

The energy dissipation distribution, stream function, and turbulent kinetic energy dissipation profile long after the baffle turn are given in the Configuration Appendix. [3], [4], and [5] for each configuration is given in the **Performance Parameter Appendix**.

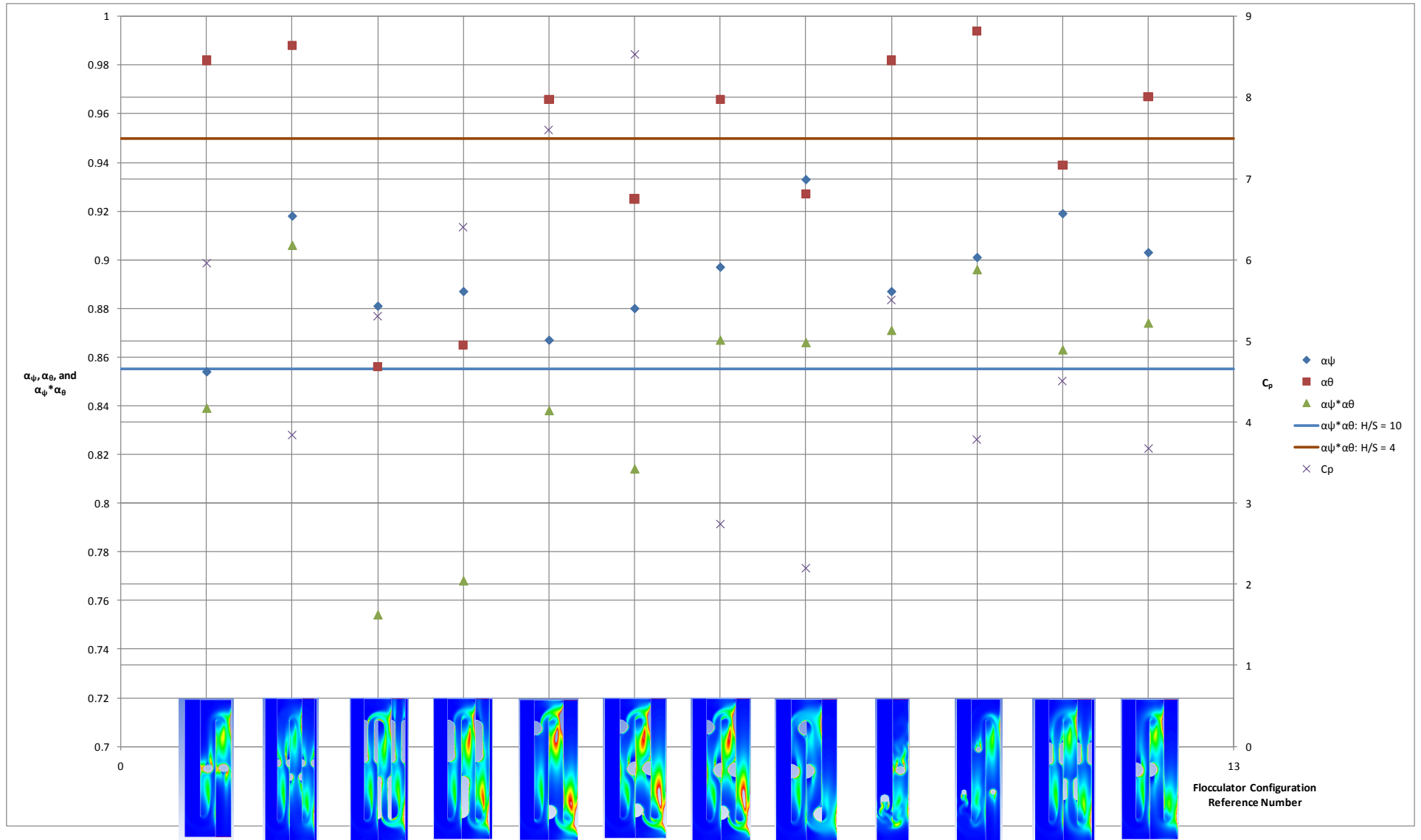


Figure 15: Dimensionless relationships for each flocculator configuration

The configurations of obstructions in the flocculator increase the flocculation efficiency, however, all of the obstructions decrease the residence time of flocculation, an inherent inefficiency for flocculation. Total efficiency shows the standard H/S = 10 flocculator surpasses some configurations of flocculators with obstructions. The images of turbulent kinetic energy dissipation show zones of turbulent kinetic energy dissipation concentration, which is not descriptive of effective flocculation. Configuration (2) gives the greatest efficiency of 90.6%, about 5% greater than the standard H/S = 10 and about 5% less than the efficiency of H/S = 4.

Reference Number	Flocculator $\varepsilon \left[ \frac{mW}{kg} \right]$
(1)	0.0023
(2)	0.0016
(3)	0.0026
(4)	0.0032
(5)	0.0037
(6)	0.0035
(7)	0.0012
(8)	0.0018
(9)	0.0011
(10)	0.0015
(11)	0.0023
(12)	0.0023
H/S = 10	0.0014
H/S = 4	0.0069

**Table 3:**  $\varepsilon$  in each flocculator configuration

The flocculator turbulent kinetic energy dissipation of configuration (2) has one of the lower flocculator  $\varepsilon$  of the configurations investigated and it is near the flocculator  $\varepsilon$  for the standard H/S = 10. In addition, the flocculator  $\varepsilon$  for (2) is consistent with turbulent kinetic energy dissipation 60 cm and 70 cm away from the baffle turn shown in the plot given in the **Configuration Appendix**. The consistency between the flocculator  $\varepsilon$  and the  $\varepsilon$  far away from the baffle turn displays consistency of turbulent

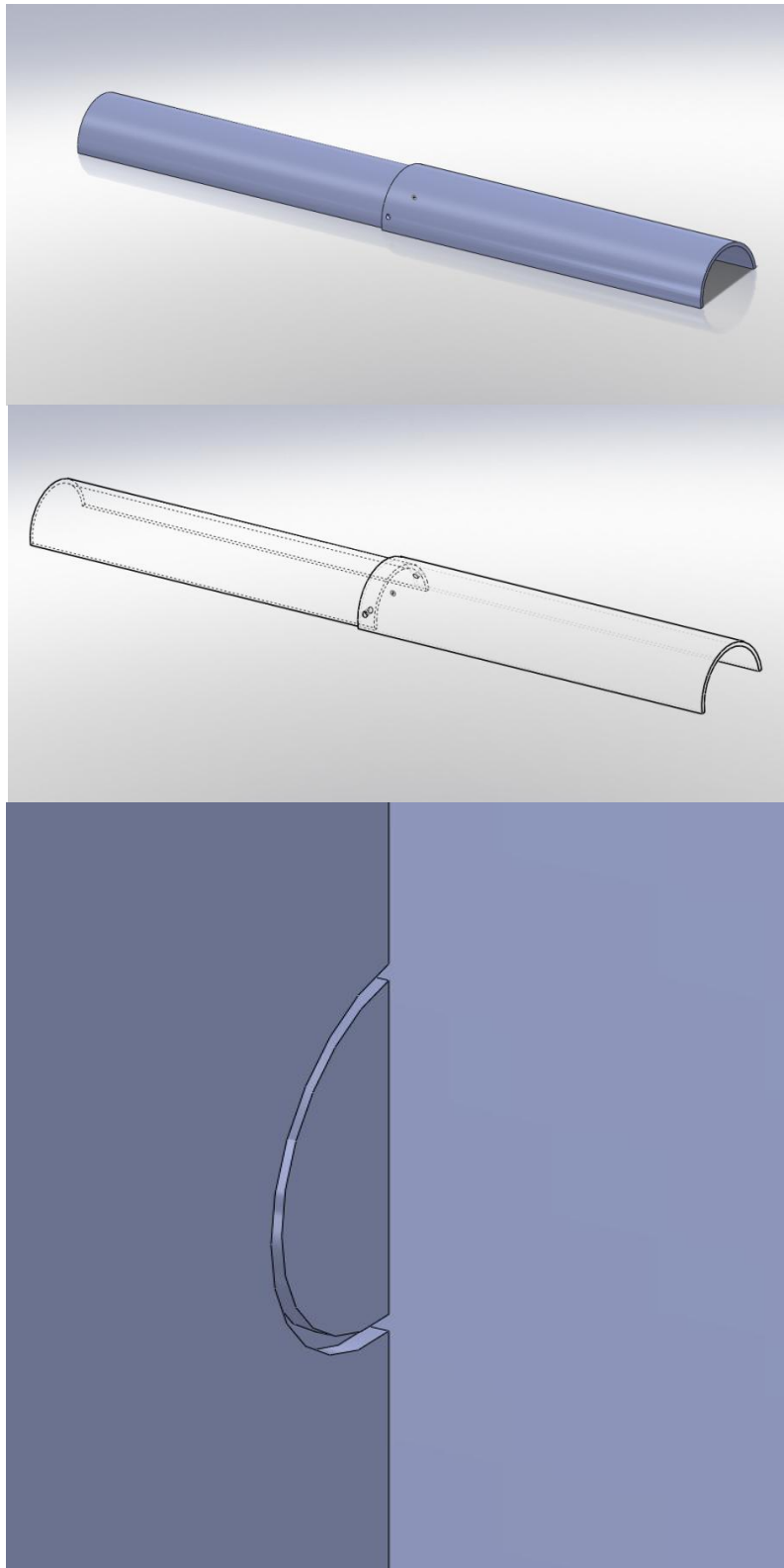
kinetic energy dissipation in the flocculator, which is effective for flocculation. Some configurations have  $\varepsilon$  far from the baffle turn that is lower than the flocculator  $\varepsilon$  by a magnitude of ten, similar to the difference in  $\varepsilon$  far from the baffle turn and flocculator  $\varepsilon$  for standard H/S = 10 in **Figure 3**. Having  $\varepsilon$  far from the baffle turn that is consistent with flocculator  $\varepsilon$  shows decrease in the dead zones in the flocculator caused when H/S increases.

## 5. Design and Conclusion

### 5.1 Design Recommendations

The H/S = 10 flocculation efficiency can be optimized by placing obstructions in the flocculator. Configuration (2) has small shapes which take up little flocculator area, minimizing the decrease in residence time. The positioning of the half circles at 45 cm and 55 cm from the base of the flocculator can be implemented in the AguaClara water treatment plants. Any addition to the flocculator should not be permanent because the half circles will need to be removed when the flocculator channel is cleaned or if the baffles in a vertical flocculator are adjusted. The slot in the channel wall for the pipe can be plugged if the pipe is not used. The obstruction can be implemented during plant construction or in existing AguaClara plants since the flocculator channel walls are covered in cement shown in the **AguaClara Water Treatment Appendix**. Positions for a removable half circle pipe can be put the water treatment plant during construction or adjusting an existing flocculator channel. The space for the half circle can be held by placing the pipe in the wall while the cement is setting in construction.

The obstruction design for the flocculator in **Figure 16** is not the same diameter for the entire length because it is removable. To match configuration (2), the obstruction is designed to be made from 2.5 mm thick PVC pipe. PVC pipe is readily available to AguaClara and used in the water treatment plants. The 5 cm and 5.5 cm PVC pipe is cut in half and holes are drilled so the pipes can be screwed together. The pipes are placed in the slots set in the flocculator channel wall, shown in **Figure 16**, and are screwed together. Similarly, the pipes are unscrewed and then removed. The dimensions and screws for attaching the pipes are given in the **Flocculator Obstruction Design Drawing Appendix** and the positioning is given by (2) in **Configurations for Flocculator Obstructions**.



**Figure 16:** Removable half circle obstruction for  $H/S = 10$  flocculator and slot in flocculator channel wall for pipe placement next to the baffle

## **5.II Conclusion**

The total flocculation efficiency can be improved by placing obstructions in the flocculator although the residence time is reduced. Configurations (2) and (10) improve the flocculation efficiency of the standard  $H/S = 10$  flocculator by about 5% and decrease area the least or have the greatest residence time efficiency. It is possible that configuration (10) is inaccurate because of the unrealistic uniform shedding from the obstruction in the first baffle space. These configurations have smaller concentrations of turbulent kinetic energy dissipation than many other configurations, but their efficiencies show turbulent kinetic energy dissipation is being distributed over a greater amount of the flocculator. In general, turbulent energy dissipation may be more evenly distributed when flow passes over a smaller obstruction with a wider passage space. The optimal configuration is a good platform for future investigation.

## Performance Parameter Appendix:

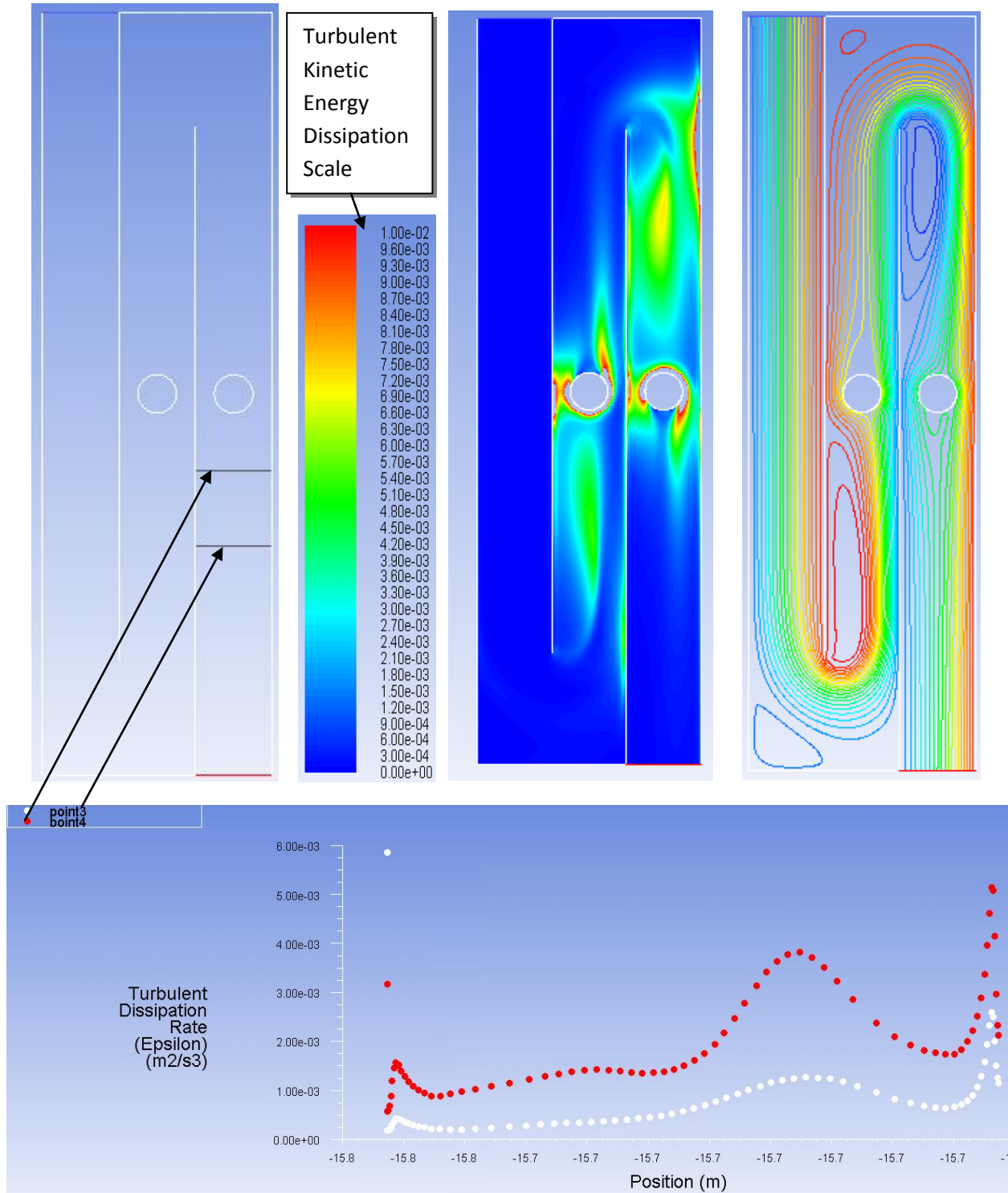
Reference Number	$\theta_{Baffle}\varepsilon^{1/3} \left[ m^{2/3} \right]$	$\theta_{Baffle}\varepsilon^{1/2} \left[ \frac{m}{s^{1/3}} \right]$	$\theta_{Baffle}\varepsilon \left[ \frac{m^2}{s^2} \right]$
(1)	1.11	0.4	0.023
(2)	1.07	0.36	0.016
(3)	1.04	0.38	0.022
(4)	1.13	0.43	0.027
(5)	1.3	0.50	0.036
(6)	1.24	0.48	0.033
(7)	0.92	0.3	0.012
(8)	1.05	0.36	0.017
(9)	1.07	0.37	0.018
(10)	0.98	0.32	0.013
(11)	1.13	0.41	0.021
(12)	1.17	0.42	0.023



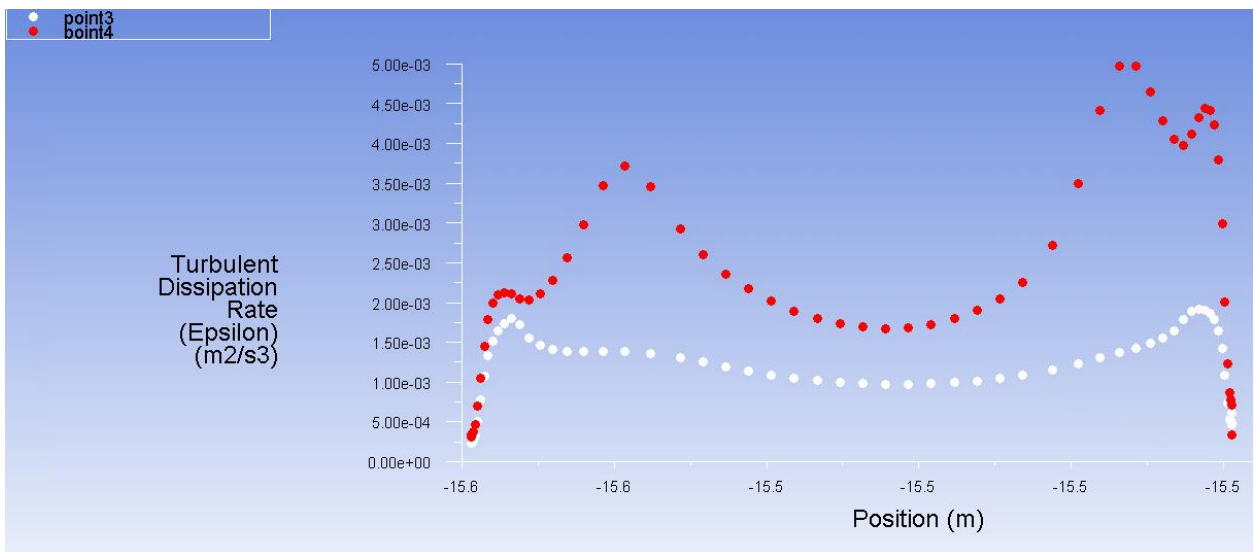
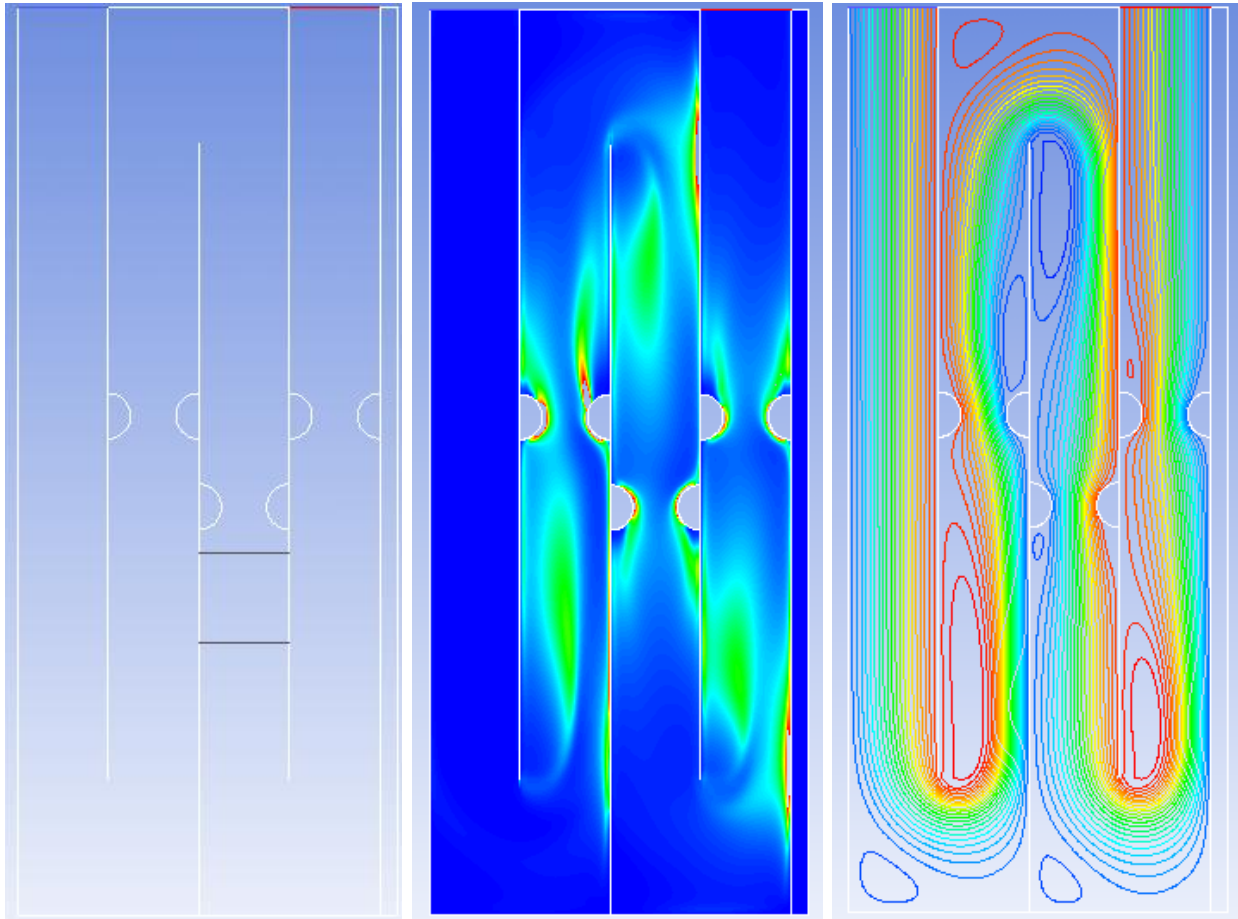
## Configuration Appendix:

Flocculator configuration outline, turbulent kinetic energy dissipation, stream function, and turbulent kinetic energy dissipation 60 cm and 70 cm away from baffle turn after first obstruction.

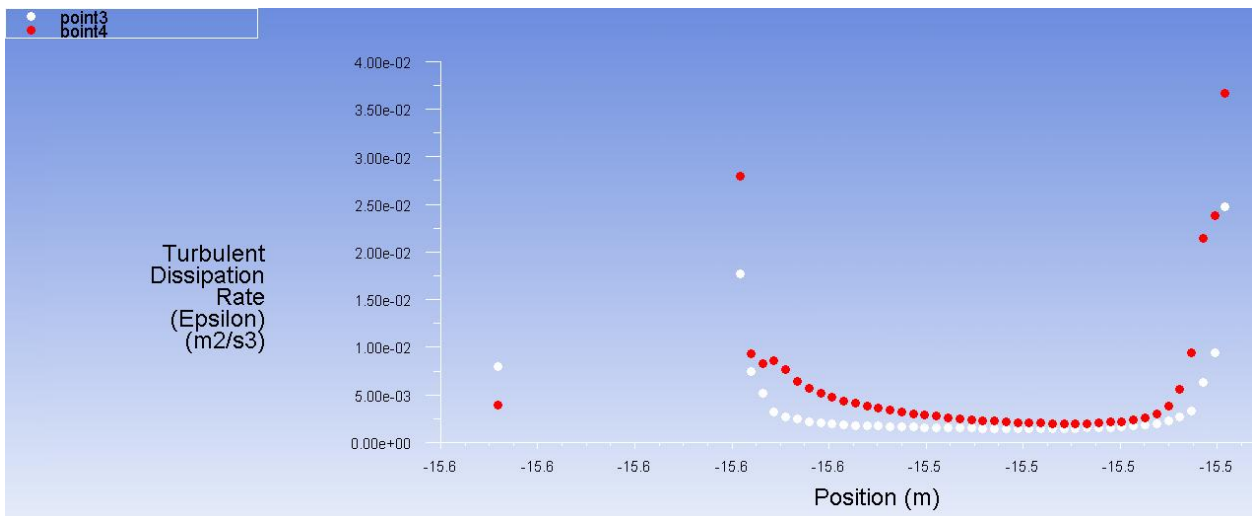
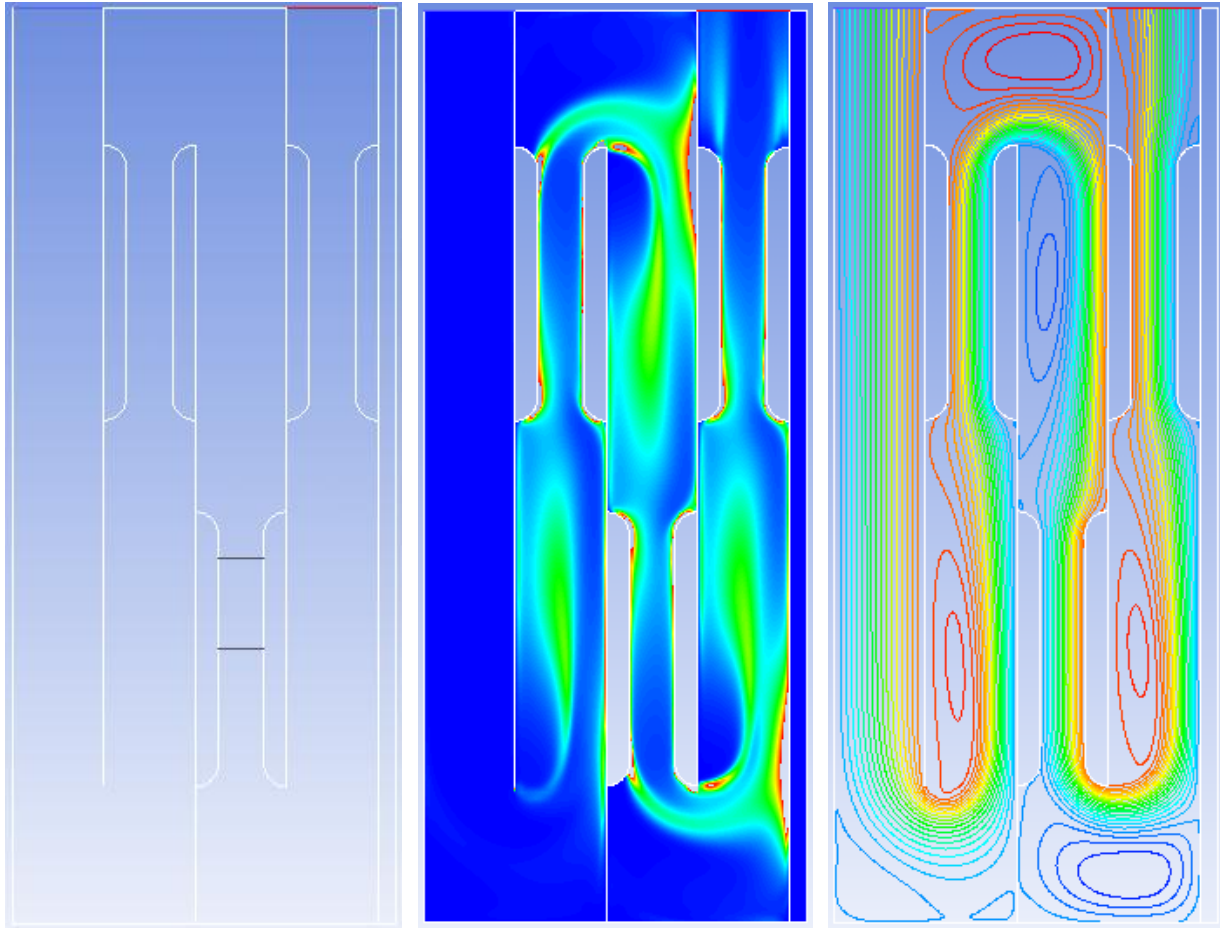
(1)



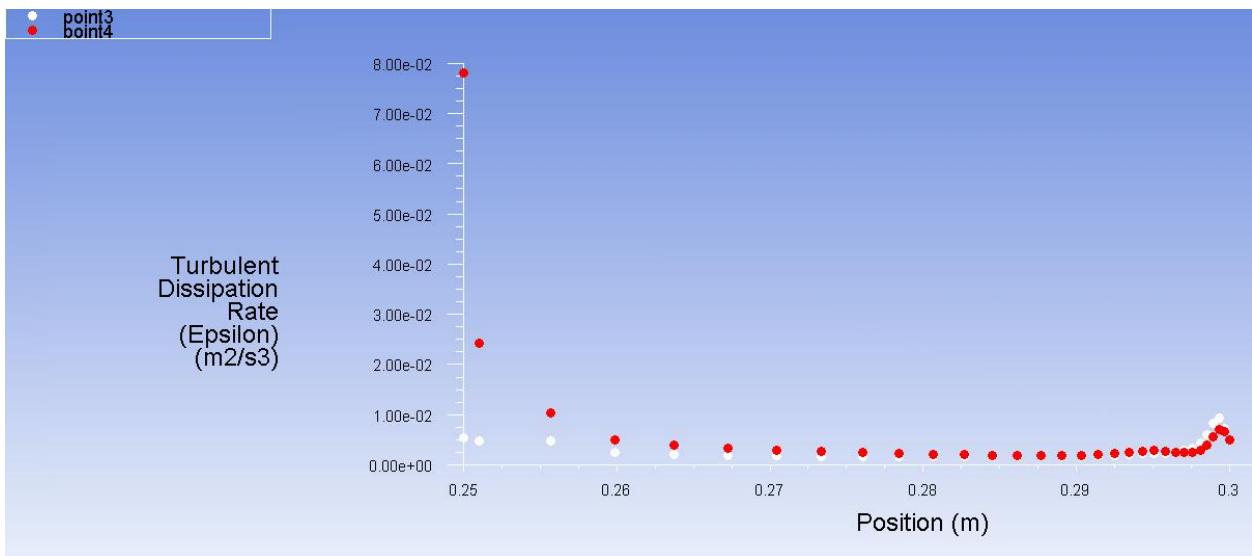
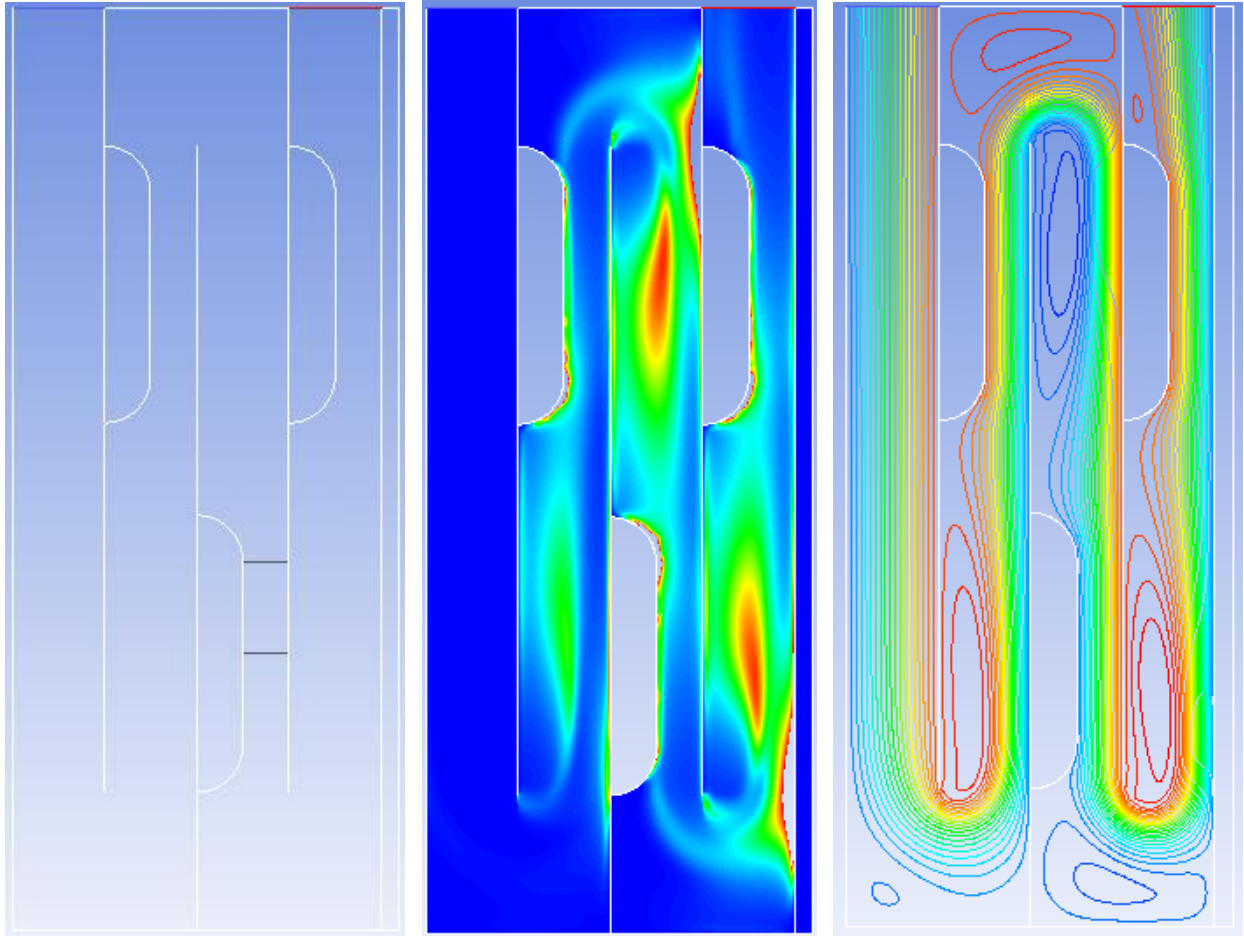
(2)



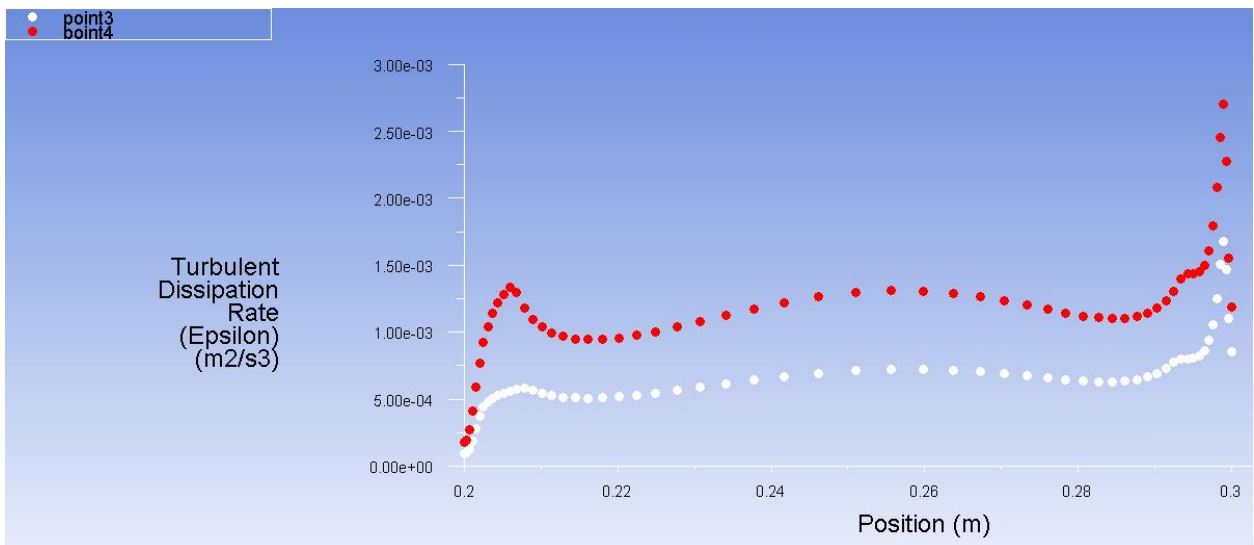
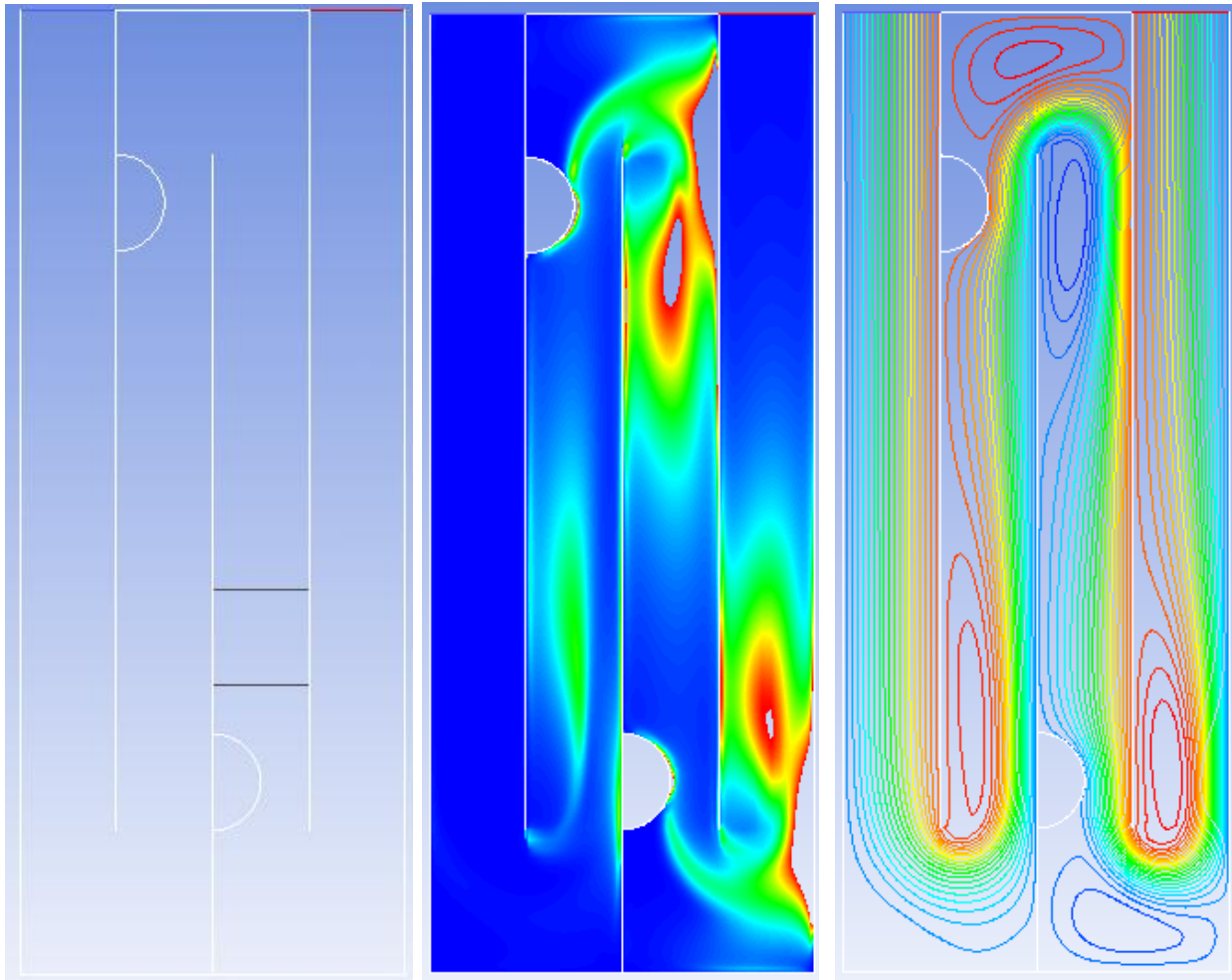
(3)



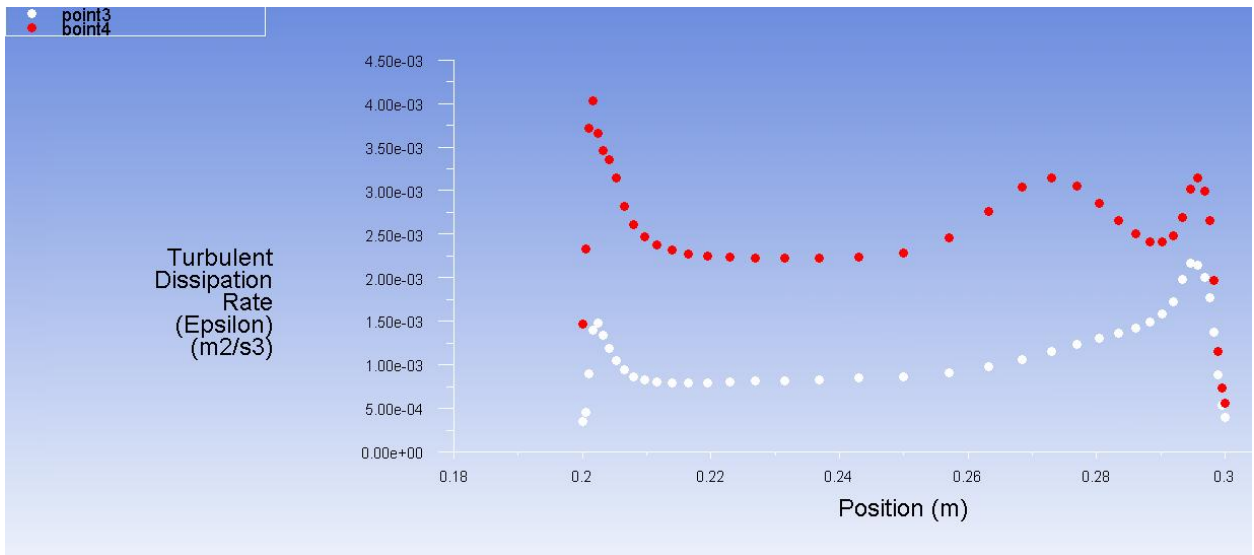
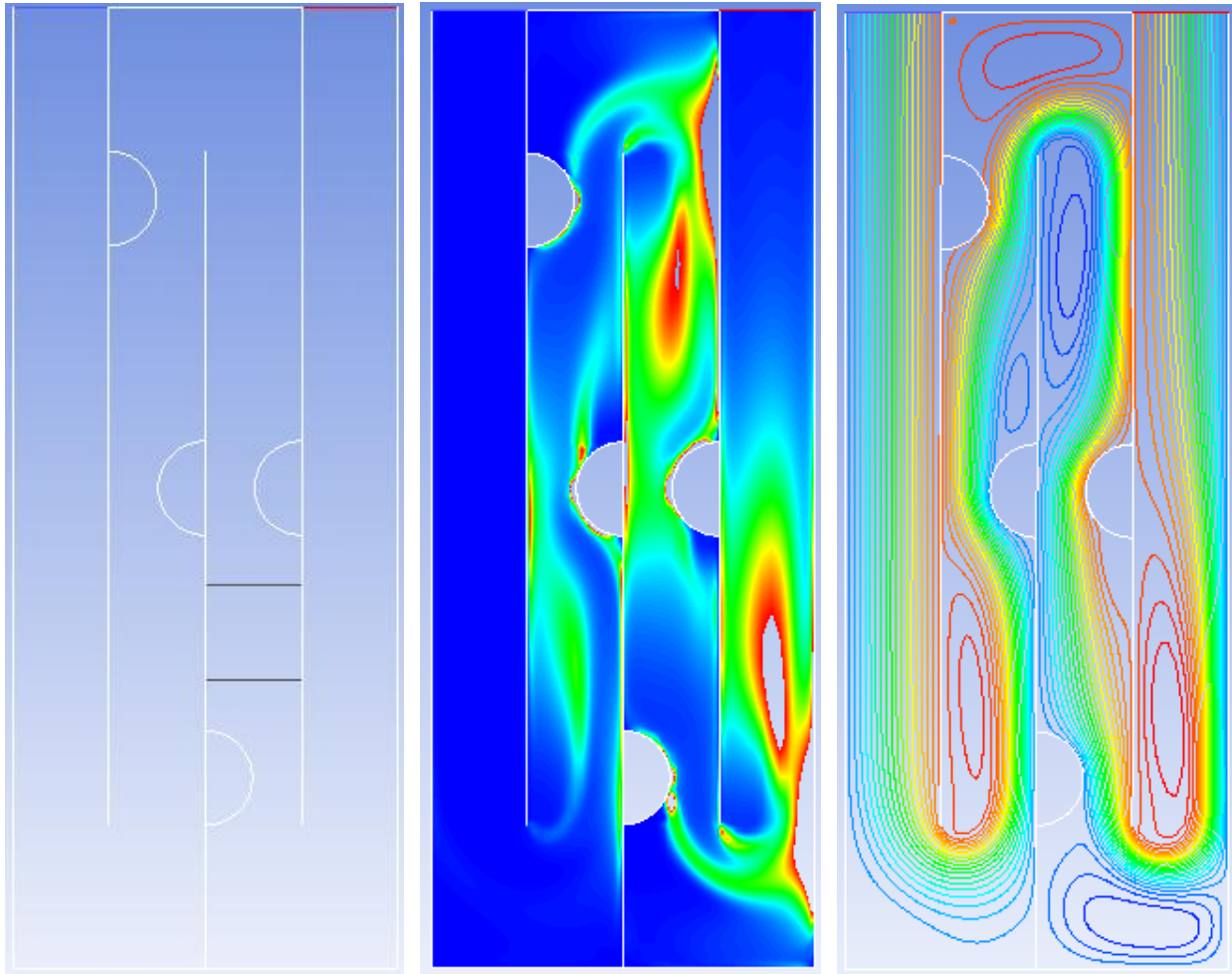
(4)



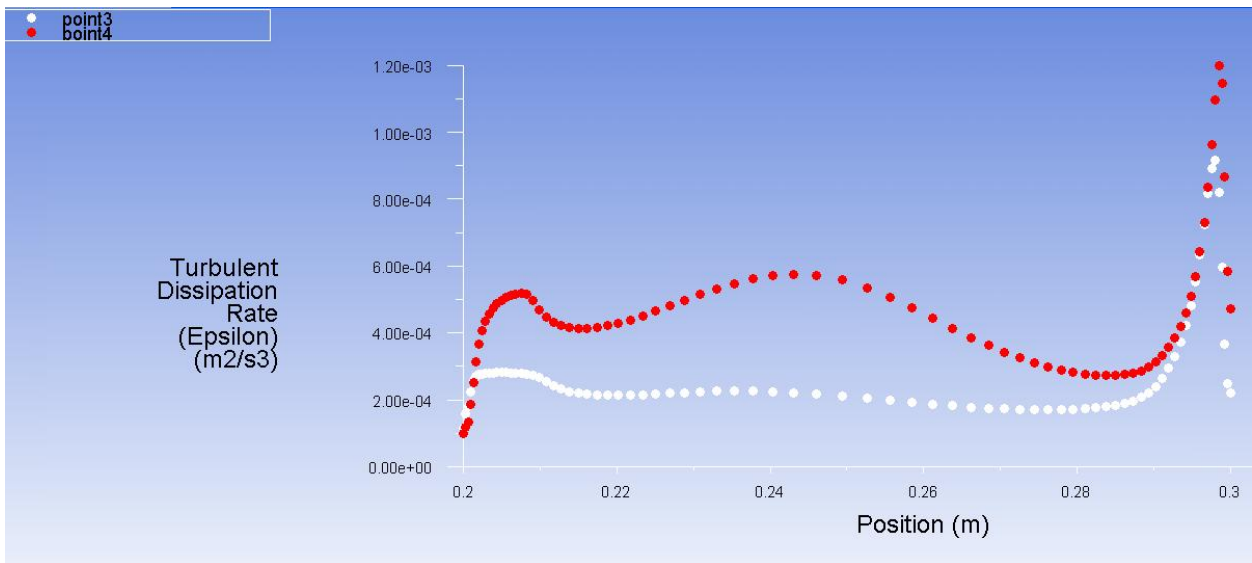
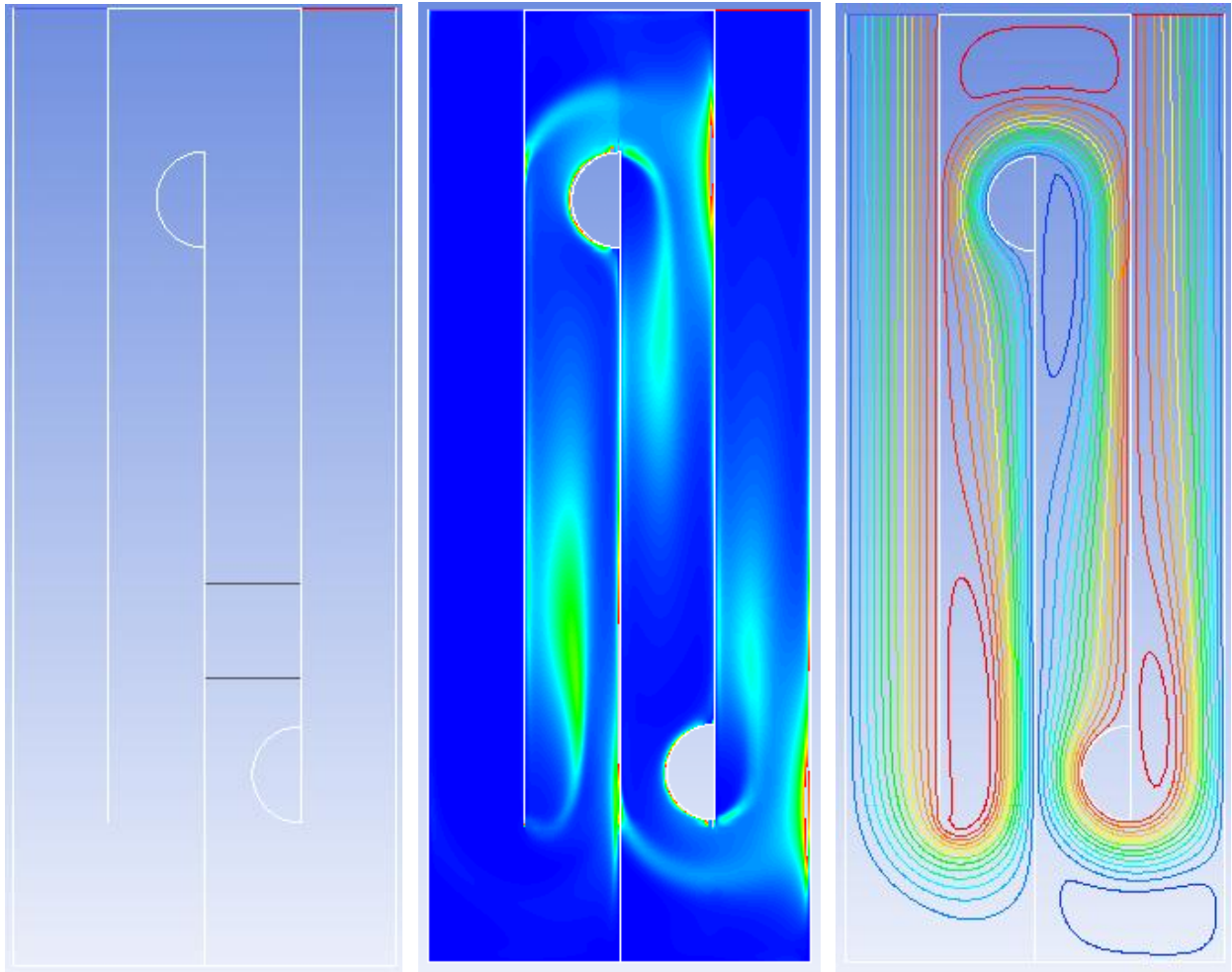
(5)



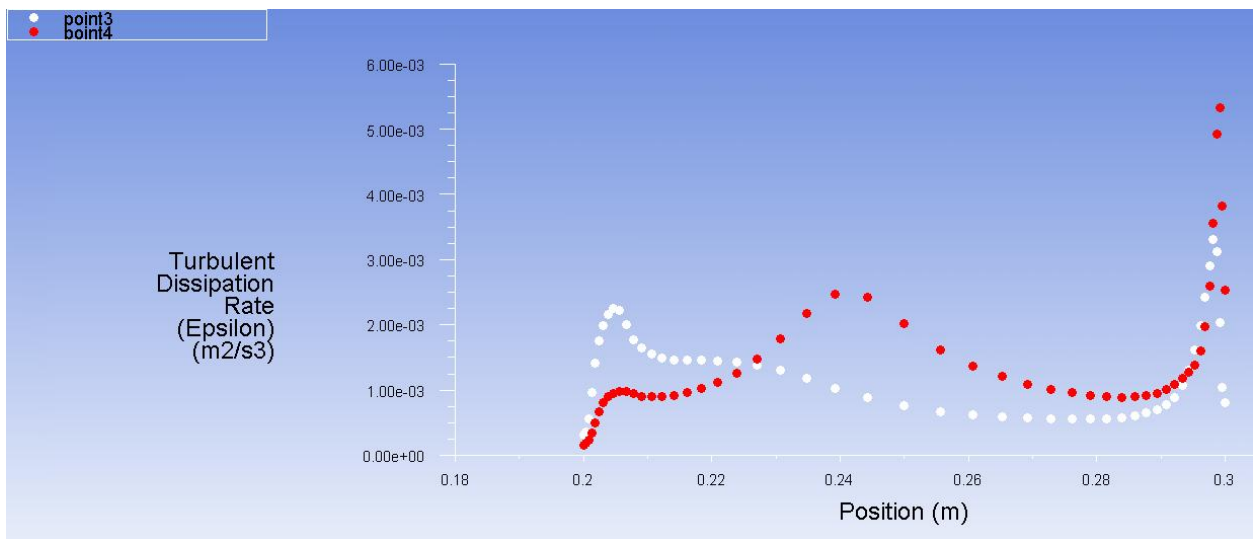
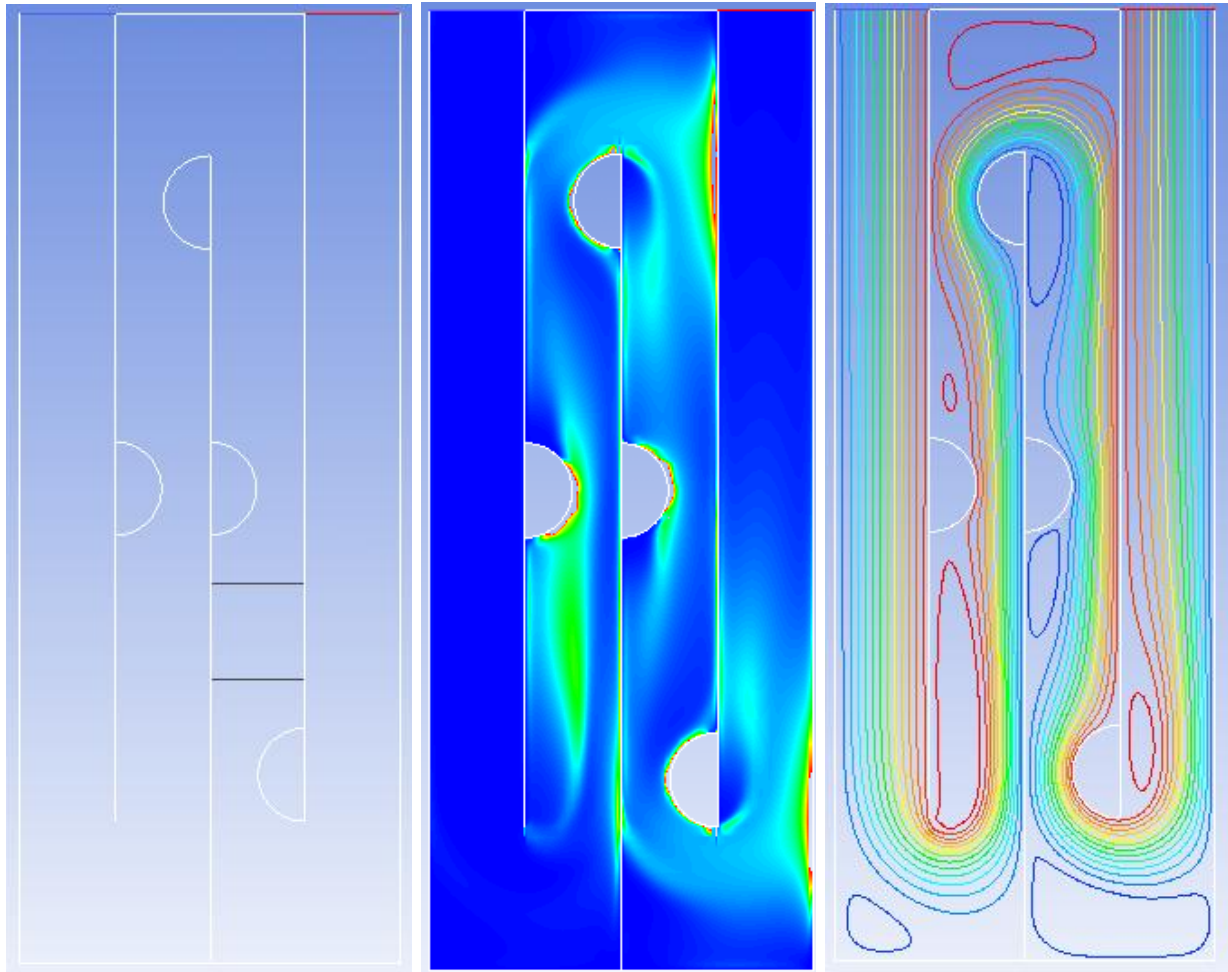
(6)



(7)

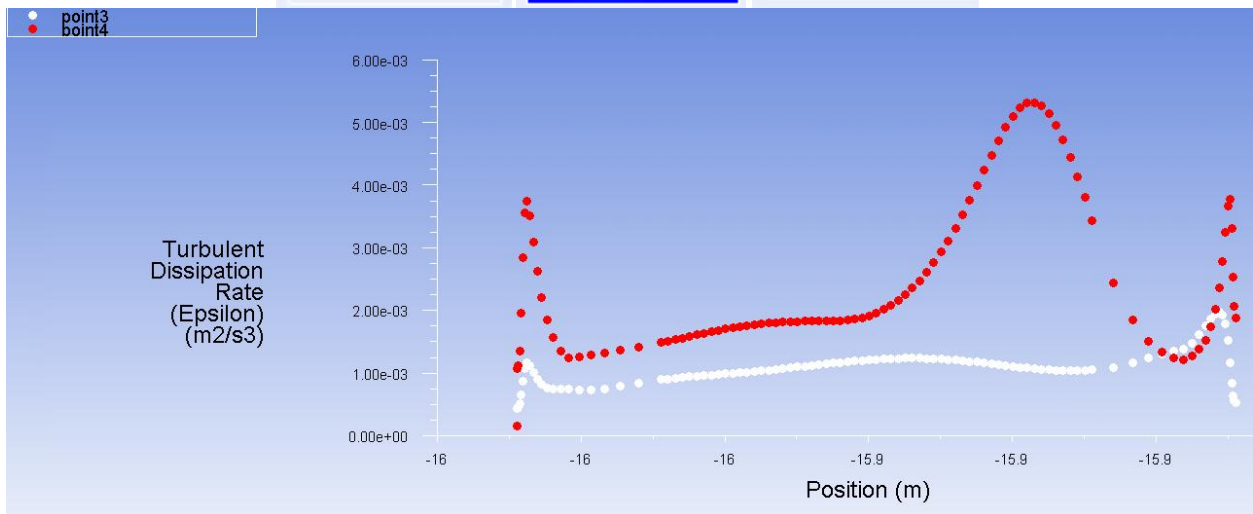
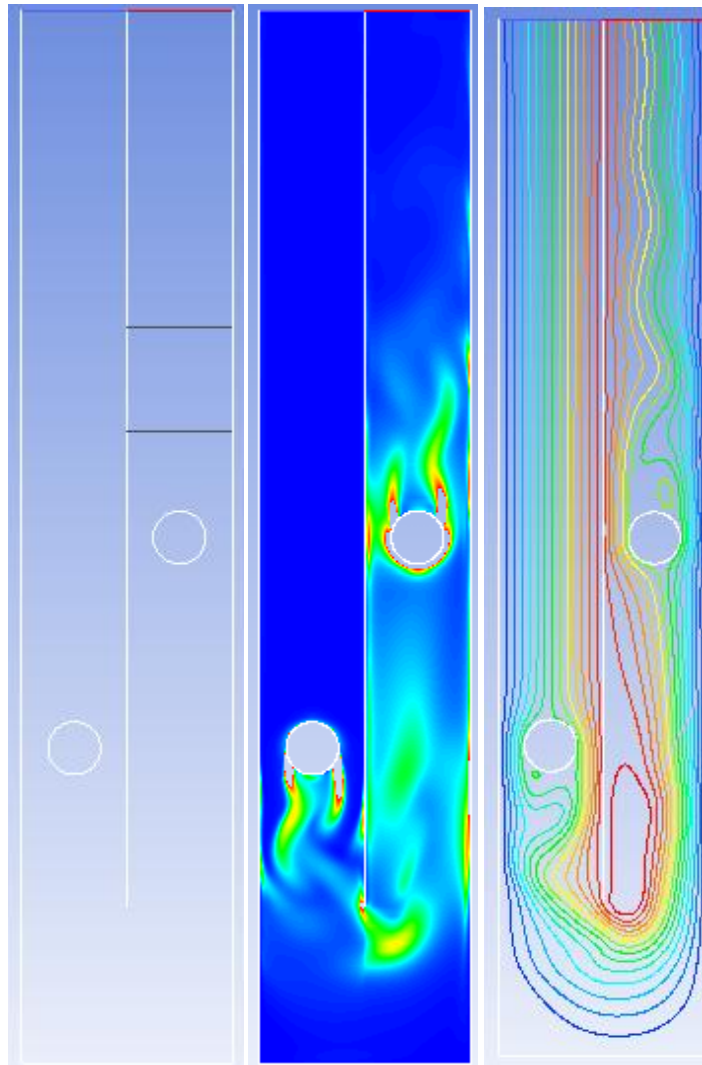


(8)

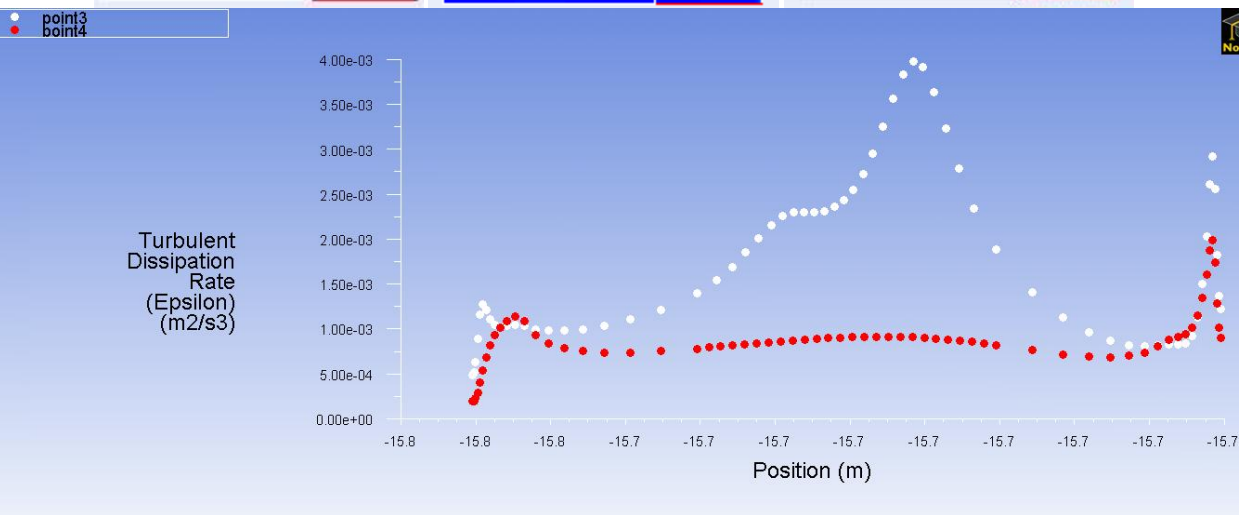
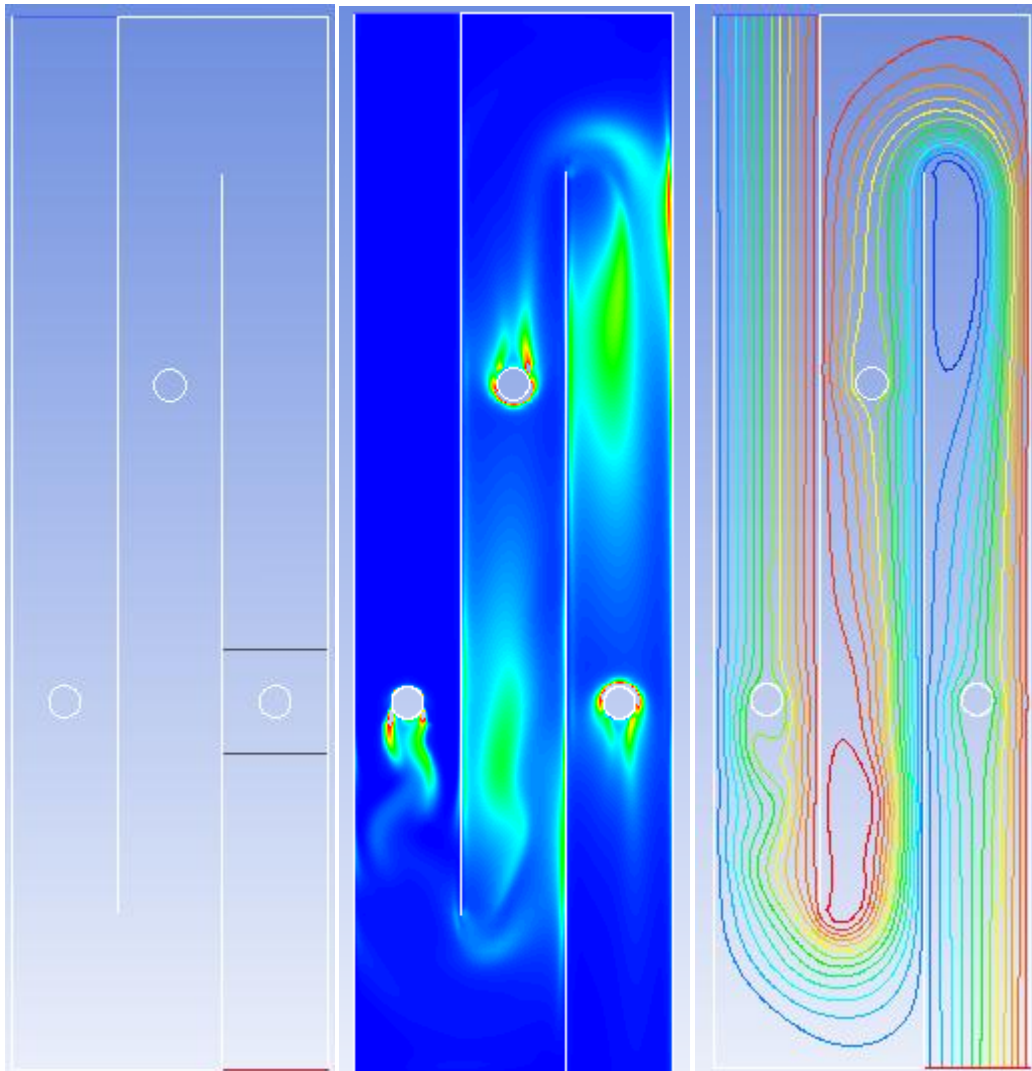




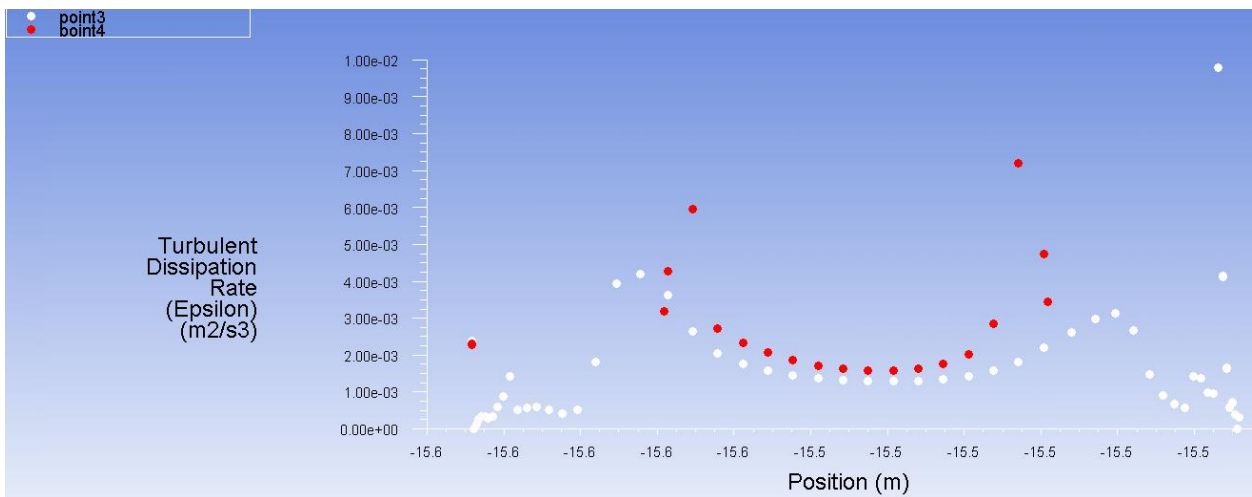
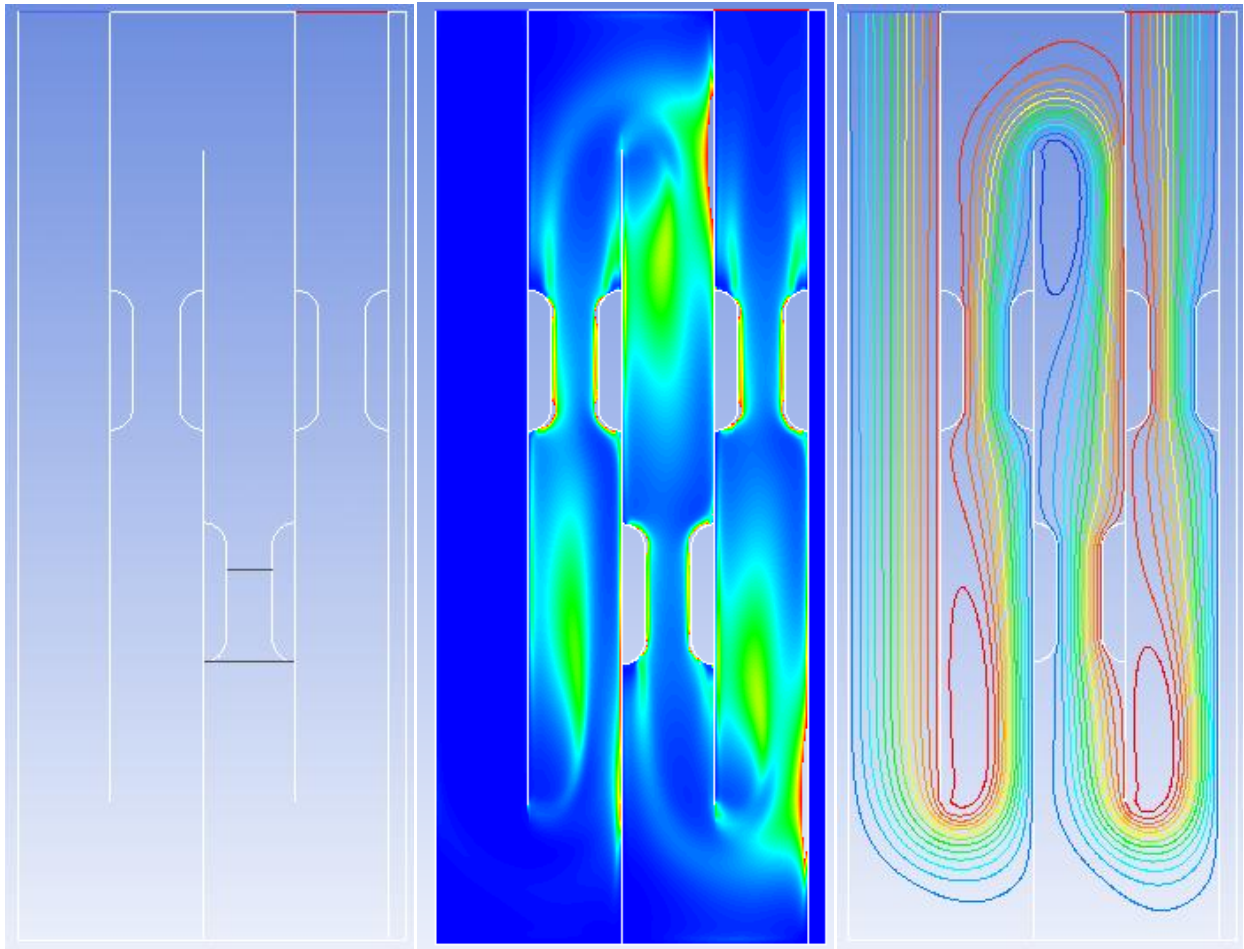
(9)



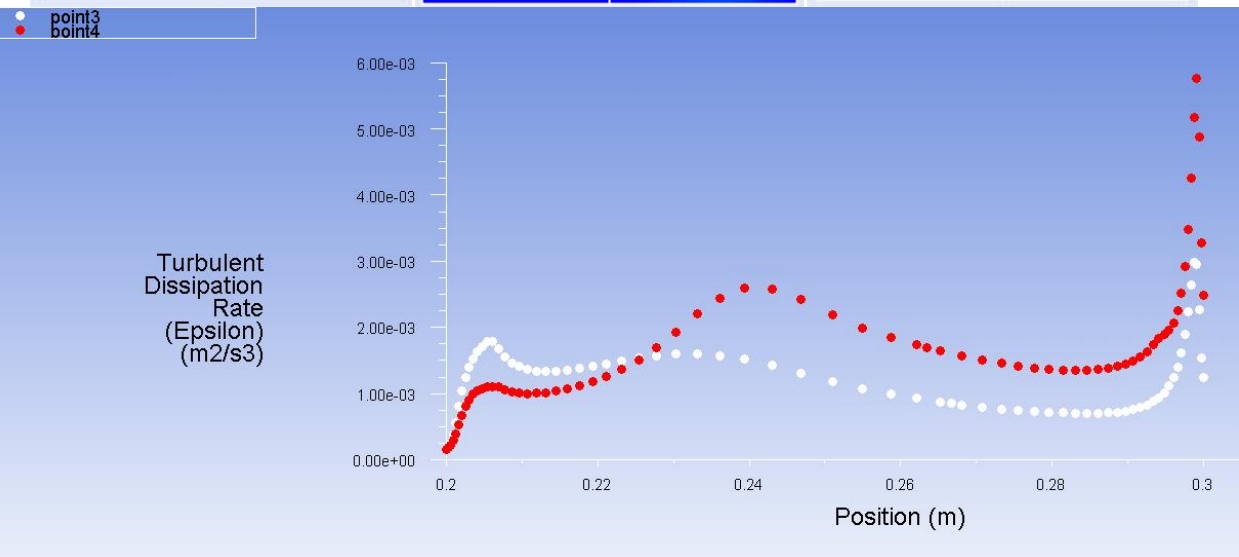
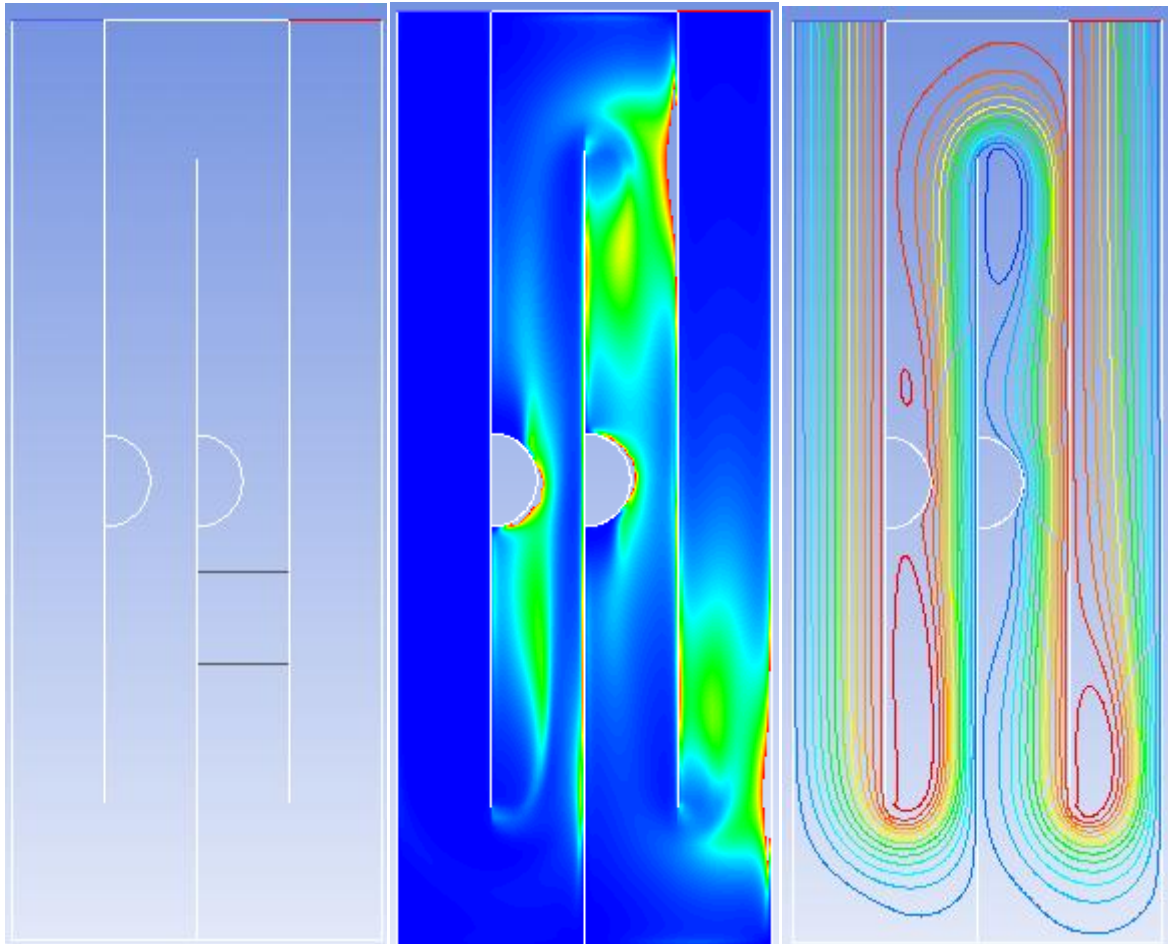
(10)



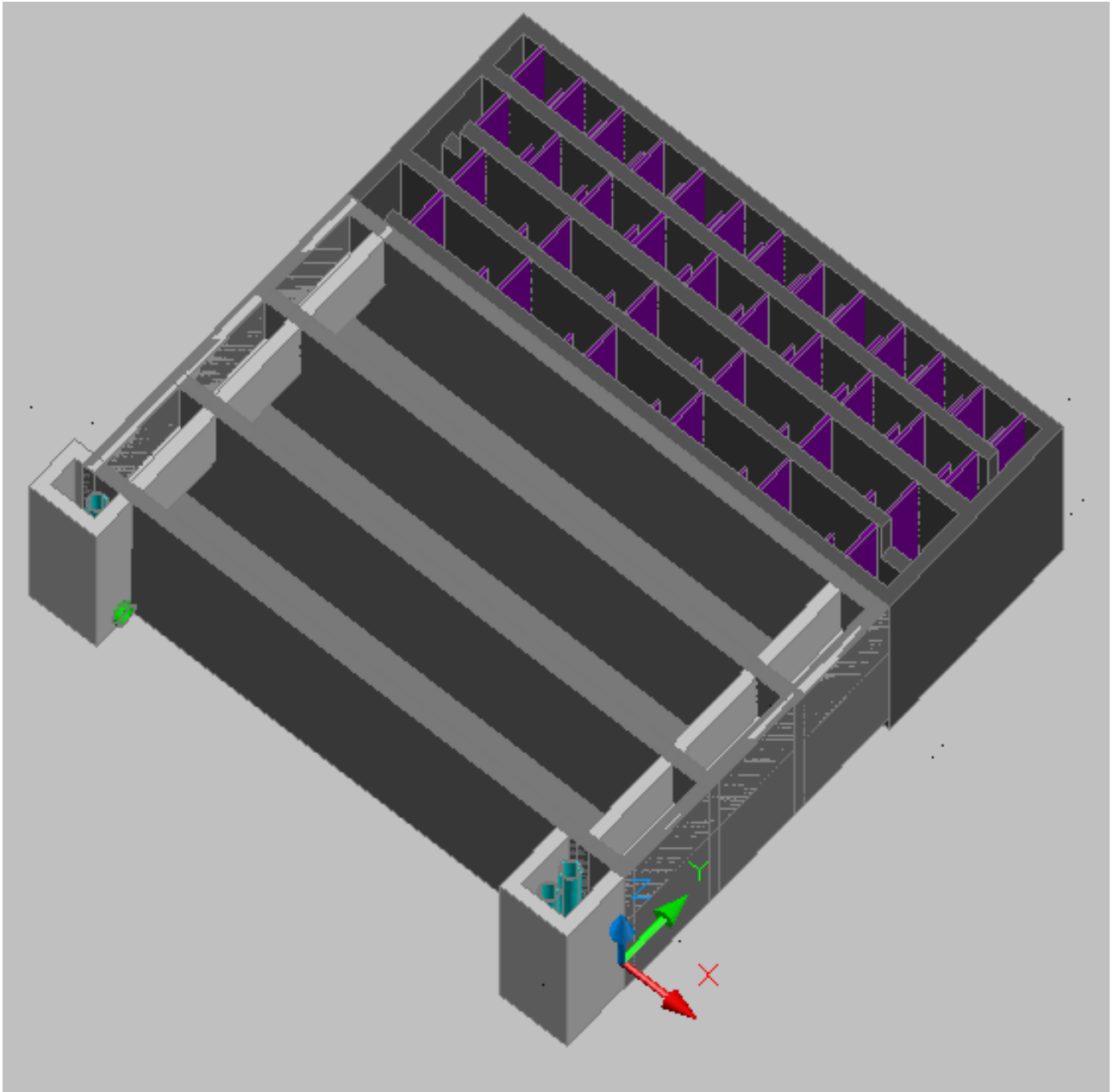
(11)



(12)



## Agua Clara Water Treatment Appendix:



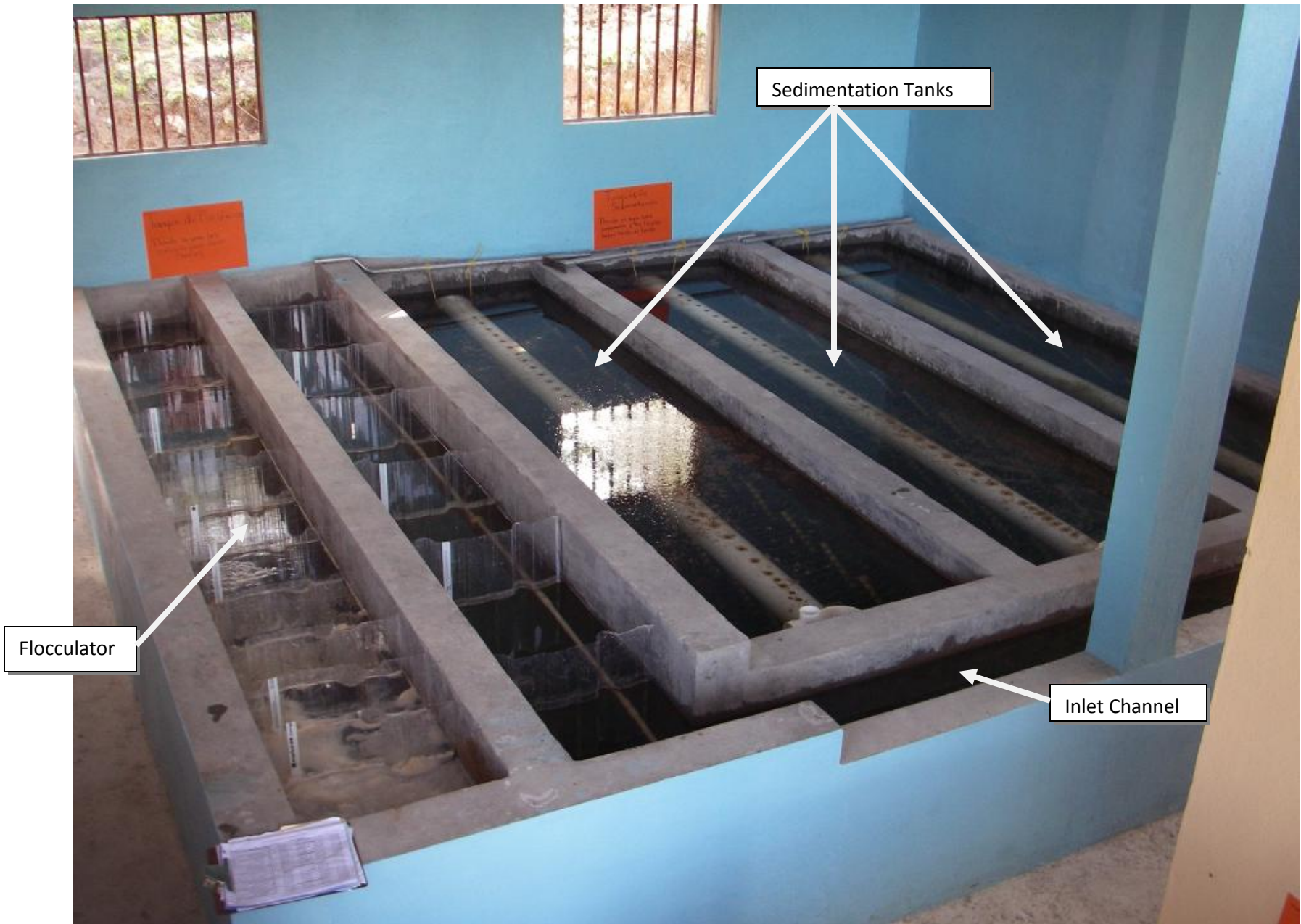
Automated Design Tool CAD model of AguaClara water treatment plant



Construction of AguaClara water treatment plant



Constructed AguaClara water treatment plant



AguaClara Water Treatment, Flocculator and Sedimentation Tank





Flocculation!!!

# Flocculator Obstruction Design Drawing Appendix:

Technical drawing of a flocculator obstruction component. The drawing includes two perspective views of a pipe with a 90-degree bend, a side view of the pipe, and a cross-sectional view. Dimensions include a length of 250, a diameter of Ø3.500, and radii of R25 and R22.500. A note specifies 'Cut Pipe in half'.

<p>PROPRIETARY AND CONFIDENTIAL          THE INFORMATION CONTAINED IN THE DRAWING IS THE SOLE PROPERTY OF          -INSERT COMPANY NAME HERE-. ANY          REPRODUCTION IN PART OR AS A WHOLE          WITHOUT THE WRITTEN PERMISSION OF          -INSERT COMPANY NAME HERE- IS          PROHIBITED.</p>		<p>DIMENSIONS ARE IN MILLIMETERS          TOLERANCES:          FRACTIONAL ±          ANGULAR: MACH ± BEND ±          TWO PLACE DECIMAL ±          THREE PLACE DECIMAL ±</p>	<p>DRAWN          CHECKED          MATERIAL          DATE</p>	<p>Use Thread Forming          Screws, 1 inch length,          Drive #2, 6-19 Thread          Size          Configuration (2)</p>
<p>MATERIAL          PVC Pipe</p>	<p>NOTE          Cut Pipe in half</p>	<p>SCALE: 1:1</p>	<p>DATE</p>	<p>REV</p>
<p>APPLICATION</p>	<p>DO NOT SCALE DRAWING</p>	<p>SCALE: 1:1</p>	<p>WEIGHT</p>	<p>SHEET 1 OF 1</p>

## User Defined Function Appendix:

The x and y positions in this code are edited to compensate for error in coordinate positioning the geometry in the ANSYS sketcher.

```

/*****
  UDF to calculate performance parameters
  *****/
#include "udf.h"

DEFINE_ON_DEMAND(Performance)
{
  Domain *d = Get_Domain(1);
  Thread *t;
  Node *nod;
  cell_t c;

  int j, q, n;

  double flow = .01;
  double fh = 1;
  //double bl_thick = .01;
  //double clearance = 0.15;
  double pos_x, pos_y;
  double xprev, yprev;
  double baffle[4] = {0, .1, .2, .3};//, .4};//, .5, .6, .7, .8, .9, 1,
1.1, 1.2, 1.3, 1.4, 1.5, 1.6};
  double Monroe_sum1[3] = {0, 0, 0};//, 0};//, 0, 0, 0, 0, 0, 0, 0, 0,
0, 0, 0};
  double Monroe_sum2[3] = {0, 0, 0};//, 0};//, 0, 0, 0, 0, 0, 0, 0, 0,
0, 0, 0};
  double Monroe_sum3[3] = {0, 0, 0};//, 0};//, 0, 0, 0, 0, 0, 0, 0, 0,
0, 0, 0};
  double Manroe[3] = {0, 0, 0};//, 0};//, 0, 0, 0, 0, 0, 0, 0, 0, 0,
0, 0};
  double display1 = 0;
  double display2 = 0;

  /* Loop over all cell threads in the domain */
  for (q = 0; q <= 2; q++)
  {
    thread_loop_c(t,d)
    {
      begin_c_loop(c,t)
      {
        double delta_x = 0;
        double delta_y = 0;
        double xpos_ave = 0;
        double ypos_ave = 0;
        int run_number = 0;
        for (n = 0; n < cell_type_nnodes[(int)C_TYPE(c,t)];
n++)
        {
          nod = C_NODE(c,t,n);
          pos_x = NODE_X(nod)+15.9626681077623;
          pos_y = NODE_Y(nod)-5.35606191635589;

```



## References:

Khoo, Sheng, Yong; Prager, Jesse; 2008. CFD Analysis of a Flocculation Tank and Design Recommendations.

<https://confluence.cornell.edu/display/AGUACLARA/CFD+Flocculation+Tank+Simulation>

Khoo, Sheng, Yong; Prager, Jesse; 2008. CFD Simulation Scientific Paper.

<https://confluence.cornell.edu/display/AGUACLARA/CFD+Spring+2008+Report>

Yi, Wenqi, 2009, Parameters Analysis in 2D – simulation experiments.

<https://confluence.cornell.edu/display/AGUACLARA/performance+parameters+analysis+in+2D+-+simulation+experiments>

Southern, Steven, 2009. Flocculation Tank Simulation.

<https://confluence.cornell.edu/display/AGUACLARA/Fall+2009+CFD+Flocculation+Tank+Simulation>

Weber-Shirk, Monroe, 2009, Flocculation. <https://confluence.cornell.edu/display/cee4540/Syllabus>

Figure 1 <https://confluence.cornell.edu/display/AGUACLARA/Project+Sites> and googlemaps

Figure 2, Figure , Figure 4, Figure 7, Figure 9, Figure 10, Figure 11, Figure 12, Figure 13, Figure 14, images in Figure 15, images in Configurations for Flocculator Obstructions, and images in Configuration Appendix were obtained from ANSYS Fluent.

Figure 16 and Flocculator Obstruction Design Drawing Appendix were obtained from SolidWorks.

Images in AguaClara Water Treatment Appendix obtained from <https://AguaClara.cee.cornell.edu> and Weber-Shirk, Monroe, 2009, Flocculation. <https://confluence.cornell.edu/display/cee4540/Syllabus>

ANSYS Fluent Operational Manual

## Senior Design Report Cover Sheet:

1. The obstructions placed in the flocculator increase the total efficiency of flocculation for a tall baffle configuration,  $H/S = 10$ .
2. The Flocculator is the mechanism that collects the turbidity in the water in flocs that are separated from the water by the floc blanket in the sedimentation tank. The flocs break in the flocculator when the flocculator turbulent kinetic energy dissipation is too high, but the flocs become too large and settle in the flocculator or inlet channel when the flocculator turbulent kinetic energy dissipation is too low. The flocculator turbulent kinetic energy dissipation must be kept below  $5 \times 10^{-3} \frac{m^2}{s^3}$  to avoid floc breakage and above the flocculator turbulent kinetic energy dissipation of the standard  $H/S = 10$  case so the flocs in the optimized case are not larger than the flocs in the standard  $H/S$ .
3. The performance objective is to find flocculator configurations to increase the total flocculation efficiency while keeping  $H/S$  and  $ch$  constant and keeping within the constraints.
4. The configurations analysed are in **Configurations for Flocculator Obstructions**. Circles were not the only obstruction considered. Plates, squares, and triangles were considered. The drag is higher on the plate and square than the circle, but flocs will get stuck on the flat surfaces. Also, I could not figure out how to mesh the triangle appropriately.
5. Ultimately total flocculation efficiency was used to decide between obstruction configurations in the flocculator. This is based on flocculation theory in Fluid Mechanics.

6. Concepts from Coursework

Course Name and Number	Concepts
MAE 323: Introductory Fluid Mechanics	Bernoulli's equation, Dimensional analysis, Turbulent flows, Drag, Pressure coefficient, Reynolds Averaged Navier Stokes, Velocity profiles and fully-developed pipe flow, the entire class
MAE 325: Analysis of Mechanical and Aerospace Structures	Finite Element Method
MAE 324: Heat Transfer	Reynold's Number of flow over objects and surfaces
MAE 327: Mechanical Property and Performance Laboaratory	ANSYS analysis
CS 100: Introduction to Matlab and Java	Computer Coding
Math 192: Multi-Variable Calculus	Stokes Theorem, Divergence Theorem, general Mathematics
Math 294: Linear Algebra	Matrix operations
MAE 225: Mechanical Synthesis	AutoCAD and design process
MAE 402: Wind Power	General Fluid Mechanics
MAE 427: Fluid Mechanics and Heat Transfer Laboratory	Fluent simulation and post processing, general Fluid Mechanics, and technical writing
Math 191: Calculus for Engineers	General Mathematics
TAM 202: Mechanics of Solids	Force, Pressure, Stress

7. The format of the design is a configuration of the flocculator and CAD design and drawings which can be prototyped if needed.
8. The configuration increasing the flocculation efficiency is promising. Optimization of the of large H/S flocculators can be done without breaking flocs and the flocculator efficiency based on the AguaClara water treatment plant construction constraints can be increased. Future work is needed to evaluate trends and optimization of the optimal case in this design study.
9. This was a one student project.