

SOLAR LOVIN' FINAL PRESENTATION

Joe Beaudette, Sarah Clement, Margaret Ding, Catherine Hanna,
Harrison Ko, Lauren Nielson, Leif Paulson, Rachel Philipson,
Julianne Schwartz

December 7, 2010

Introduction

- **Cornell University's Solar Oven Team**
- **Partners:**
 - **Grupo Fenix, Universidad Nacional de Ingenieria, Nicaragua**
 - **Las Mujeres Solares de Totogalpa, Sabana Grande, Nicaragua**

Introduction

- **Purpose: promote renewable energy sources**
- **Means: solar ovens**
 - **Reduce need for women to gather resources for wood-burning stoves**
 - **Reduce health risks from smoke inhalation**

SUBTEAMS

- **Insulation**
- **Concentrated Cooker**
- **Small Solar Oven**

INSULATION

Sarah Clement, Harrison Ko, Julianne Schwartz

Project Summary

- **Problem:**
 - Current insulation unsatisfactory**
 - Women's group in Nicaragua observe material's lack of longevity**
 - Diminished performance of oven after a year**
- **Objective:**
 - Investigate and identify materials of insulation that would improve performance and longevity**
 - Preliminary testing scheme developed in previous semester**

Experimental Design

- **Process:**

Experiment involved isolating the heat transfer of the system through a single wall with interchangeable insulation

Experimental Design

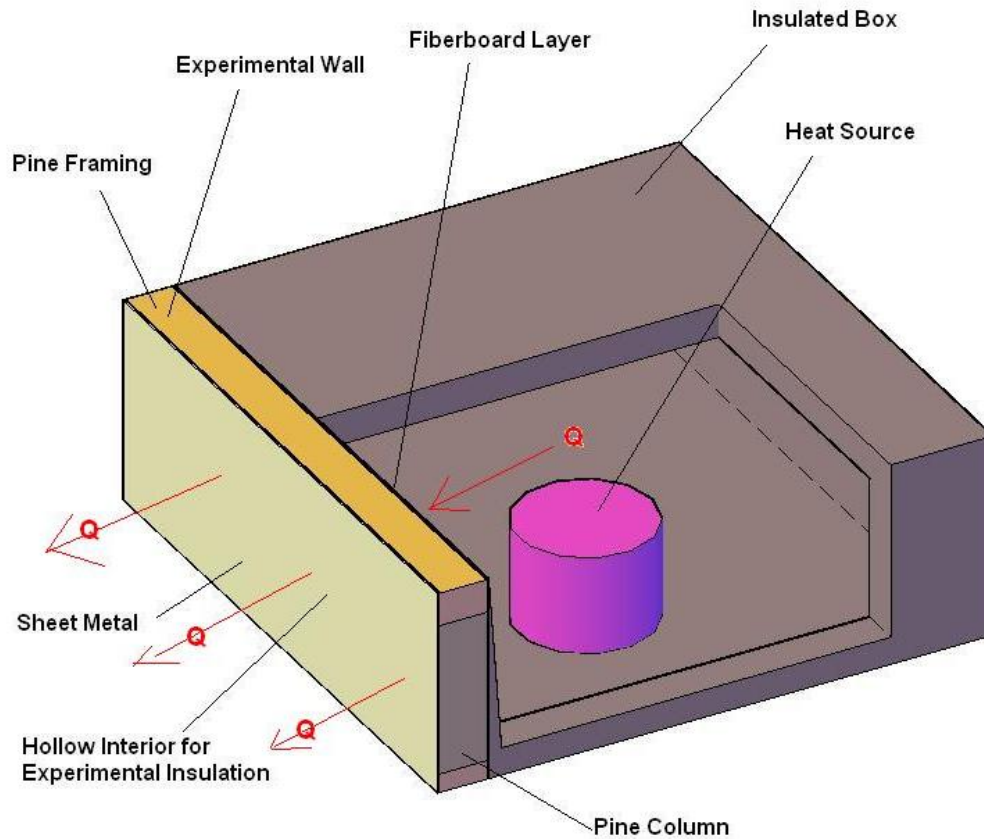

Experimental Design

- **Insulation Testing Concept**

Will have five non-experimental faces with a thermal resistivity far greater than that of experimental wall

- **Experimental Wall**

Will mimic the walls of a conventional solar oven

Main difference: Allows for interchangeable insulation

Isolate heat transfer through single wall of solar oven

Heat inside the box will travel the path of least resistance

Experimental Design



Insulation Subteam

Construction

- Outer frame
- Insulated sides
- Insulated lid
- Experimental wall



Construction

- Used old box cooker as internal casing for the heat source to mimic real conditions (oven door removed)
- Outer frame made of plywood, connected with metal brackets
- Mineral wool used for extreme insulation on the five super-insulated sides
 - Thermal resistivity roughly 10 times greater
- Experimental wall made of pine framing, same materials as ordinary solar oven wall

Construction

Change in Orientation:

- Difficulty with attaching the experimental wall to the device
- Change in orientation of the insulated box to an upright position
- Used weights on the experimental wall to create seal, so that it is easily removable



Construction

Heat source:

- Four 500W halogen light bulbs
- Bulbs and wiring attached to and held in place by a two bricks
- Measuring and control system turns on lights until temperature inside is reaches specified temperature
- Control system turns on/off lights to maintain desired temperature



Construction

- LabVIEW displays the temperature at different locations throughout the experimental unit
- Thermocouples:
 - (1) Ambient
 - (2) Inside the oven
 - (3) Against experimental wall inside oven
 - (4) Bottom of experimental wall
 - (5) Middle of experimental wall
 - (6) Top of experimental wall
 - (7) Against outside of experimental wall

Thermocouple Diagram

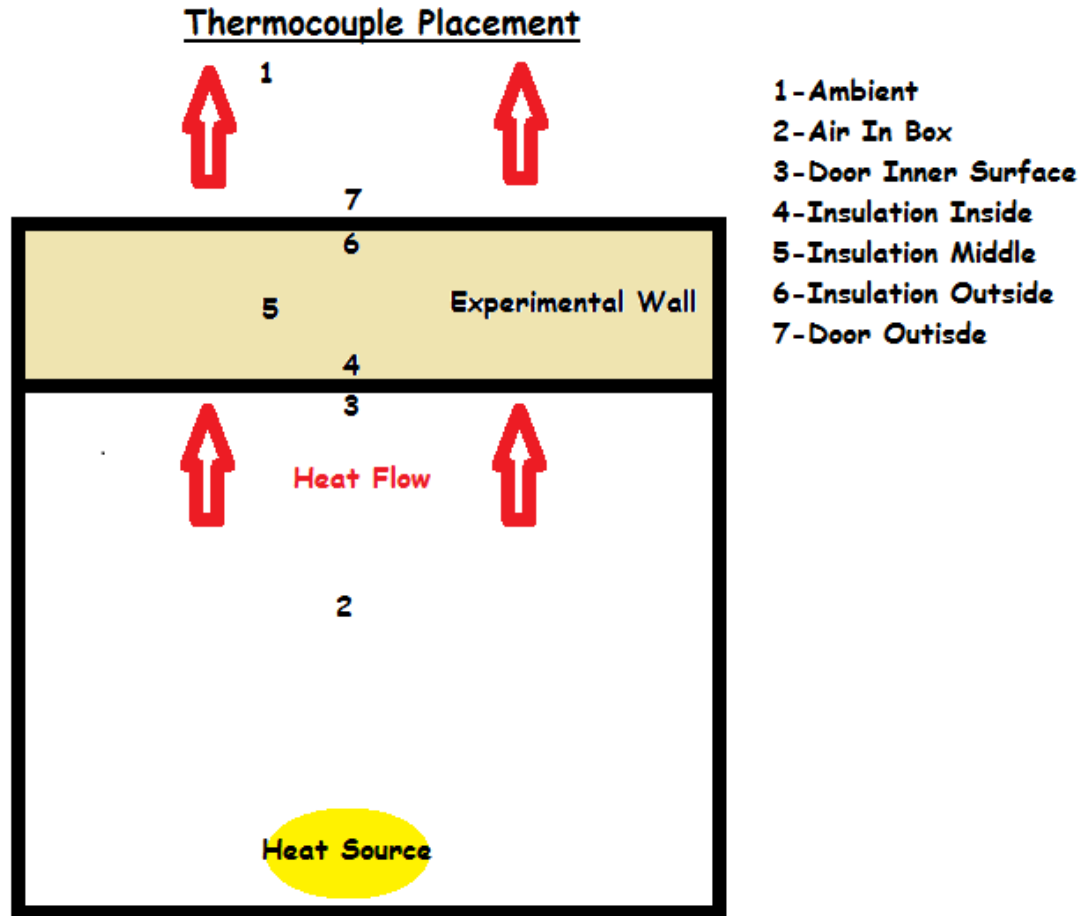

Experiment

- **Goal of Design:**
Develop an experiment to be used by future teams to test insulation
Data collected will be the temperature at each thermocouple
Experimental results will allow for the comparison of the insulation capabilities of various materials

Experiment

Insulation Materials

Tested:

(1) Air

(2) Wood Shavings

(3) Rice Hulls

(4) Fiberglass



Experimental Procedure

- (1) Place insulation material in the experimental wall and wall on experimental unit
- (2) Start LabVIEW and set the target temperature differential (data collection begins)
- (3) When the target temperature differential is achieved, continue to let run for 10 minutes
- (4) After 10 minutes, set target temperature differential to zero (which turns off the heat source and data collection ends)
- (5) Remove the experimental wall and allow the inside to cool down
- (6) Once the temperature differential has gone below 10°C , the next trial can begin

Experiment

- For each type of insulation material, three trials were run
- The same procedure was used for all three trials for each material

Results and Findings

- The typical results attained from one trial show temperature readings from each thermocouple over the duration of the test
- These results allow us to view the temperature gradient across the insulation

Results and Findings

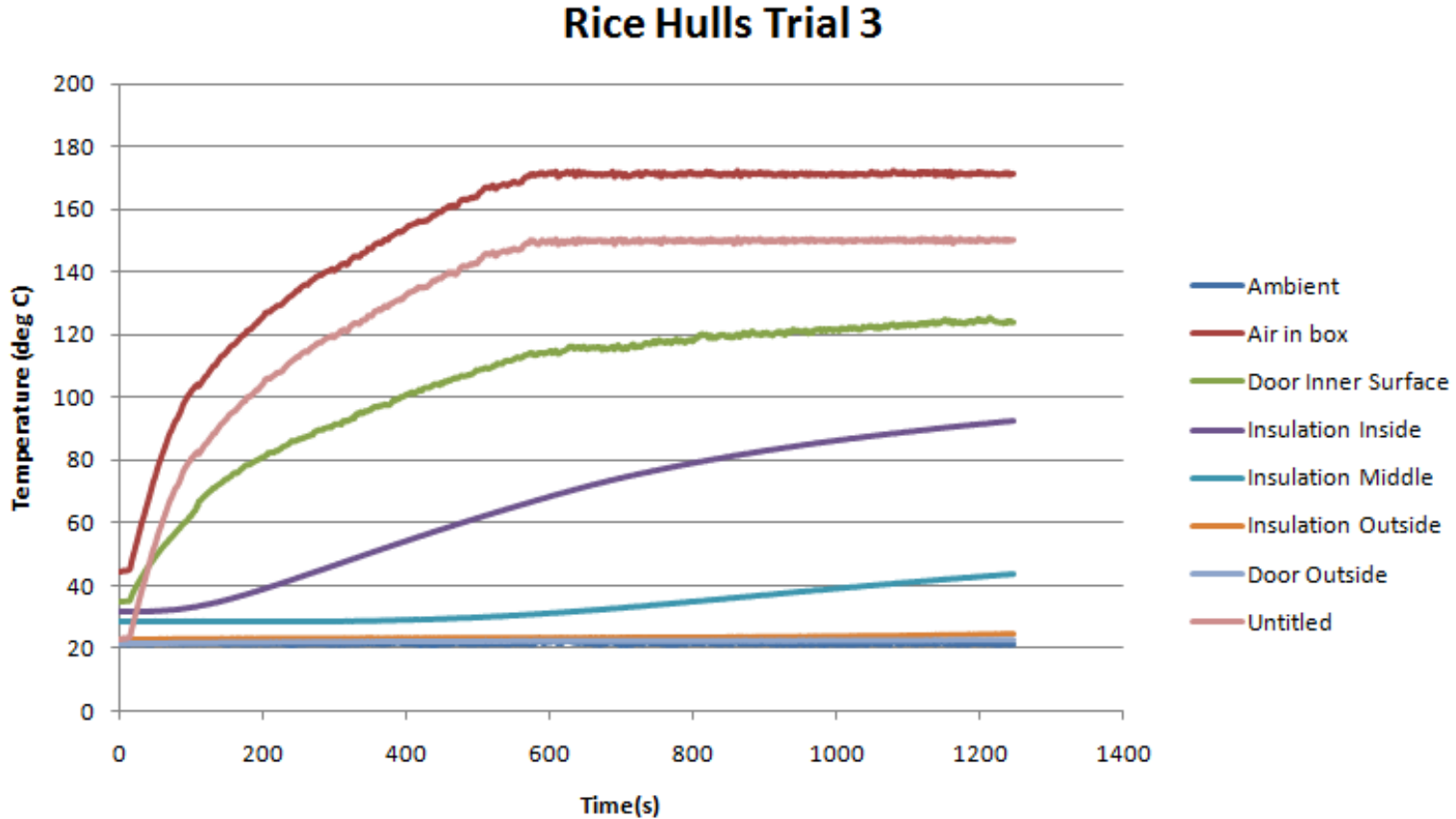

Results and Findings

- For analysis, we focused mainly on the thermocouples corresponding to “Insulation Inside” and “Insulation Outside”
- These thermocouples flank the insulation material
- Their difference gives good indication of the ability of the insulation material to store heat

Results and Findings

- The data files were analyzed by plotting the temperature difference between the 2 thermocouples over time
- The temperature difference was analyzed between the time span for when the difference was 10 degrees Celsius until the end of the experiment
- This start point and end point provided consistency for comparing the different trials

Results and Findings

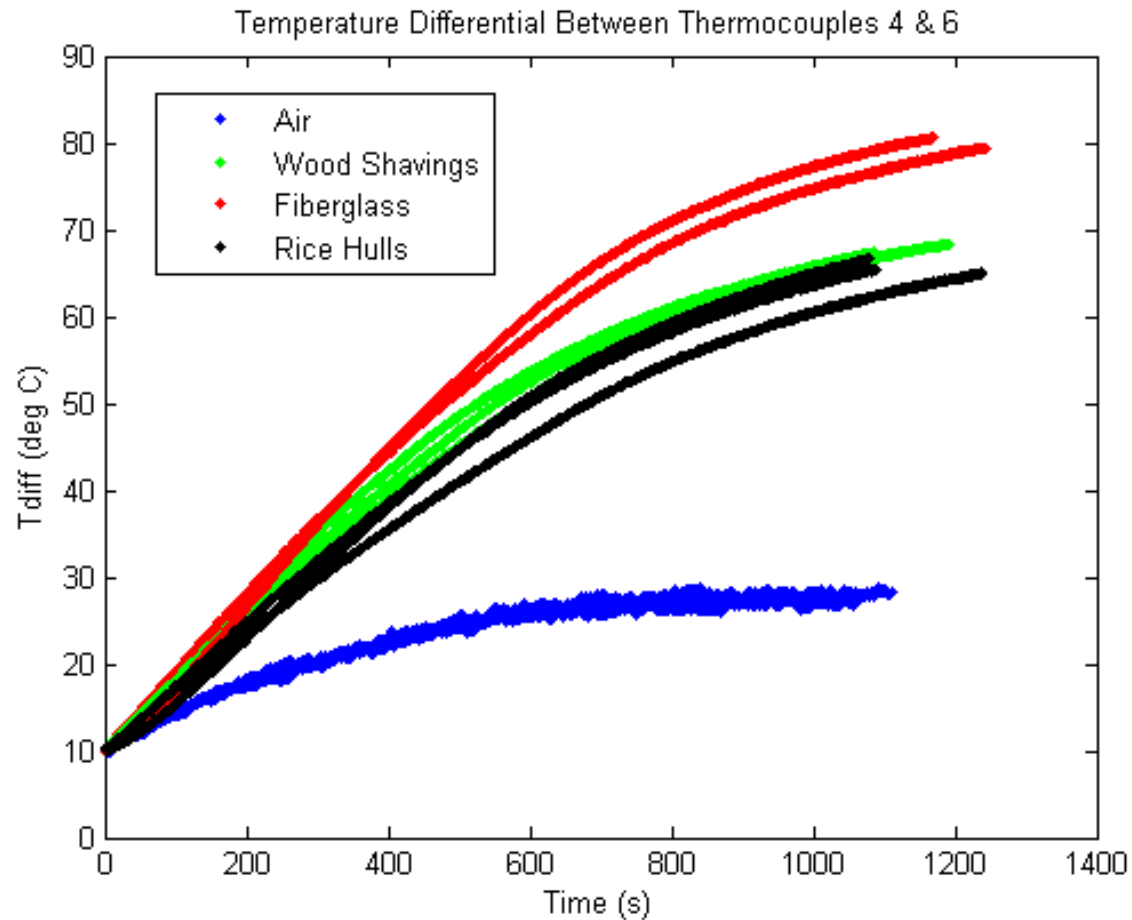

Results and Findings

- The results indicate that:
 - Temperature gradient is smallest when using air
 - Temperature gradient is greatest when using fiberglass
 - Temperature gradient is comparable between rice hulls and wood shavings

Discussion

- Based on the results it appears that we have an effective experimental setup and method
- We can see a consistent difference in the performance with different insulation materials
- The consistency with the air trials shows that the experimental method is highly repeatable

Discussion

- Variation within the trials for the various insulations indicate that there are problems with the current setup
- We speculate that these variations are due to the insulation's sensitivity to density, since density was not monitored carefully in the trials
- Additional experiments will need to be conducted with density controls to draw further conclusions

Criteria: Technical

- **Criterion: If an alternative insulation material is suggested, it must be tested to prove that it performs superior or equal to the current material used**
- **Unable to conclude that rice hulls or fiberglass would perform equal or superior to wood shavings**

Criteria: Social

- **Criterion: The Nicaraguan women accept the suggestion for using an alternative insulation material**
- **This challenge was not encountered during the semester**

Criteria: Economic

- **Criterion: The alternative insulation material must be inexpensive and readily available in Nicaragua**
- **Rice hulls and fiberglass are low-cost materials and can be found in Nicaragua**

Criteria: Environmental

- **Criterion:**

All material and energy inputs and outputs utilized during testing should be as inherently nonhazardous as possible

Attempted to design products, processes and systems that include integration and interconnectivity with available energy and material flows.

Recommendations for Future Teams

- Replicating real life situation: Issue only exists after a year of oven-use
- Entire semester was spent building and testing experimental unit, however a scheme was developed to test this issue
- Typical solar oven goes through one heating and cooling cycle a day
- Accelerating time: Computer system can be set to run through heating and cooling cycles automatically
- Degradation will appear after a shorter testing period

Conclusion

Based on the results from this study, the following conclusions can be drawn:

- (1) The experimental method is an effective way to test and compare various insulation materials
- (2) The results indicate that using fiberglass as an insulation material results in the greatest temperature differential across the insulation
- (3) Wood shavings and rice hulls appear to be comparable in temperature differential
- (4) Air appears to be worse than all other forms of insulation used in this study
- (5) Further experimentation with density control will be necessary to draw more concrete conclusions
- (6) An optimum insulation cannot be suggested until performance over time is investigated

CONCENTRATED COOKER

Margaret Ding, Catherine Hanna

Project Summary

- Problem:

Current solar oven design does not reach high enough temperatures to fry foods

Current solar oven max temp = 180 C

Min temp needed to fry foods = 250 C

- Objective:

Research, design, and build a concentrated cooker that meets temperature requirements

Design Choices

- Spherical vs. Parabolic: Parabolic
Spherical aberration

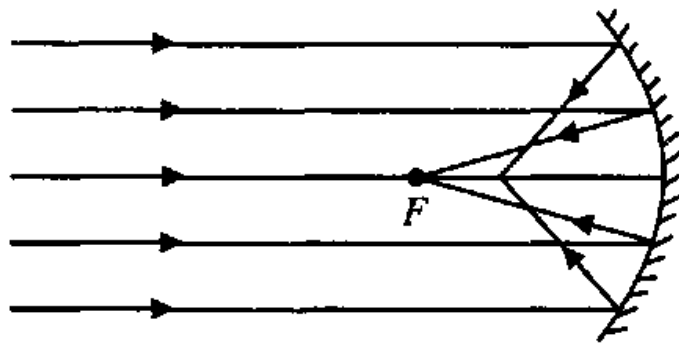

(a)

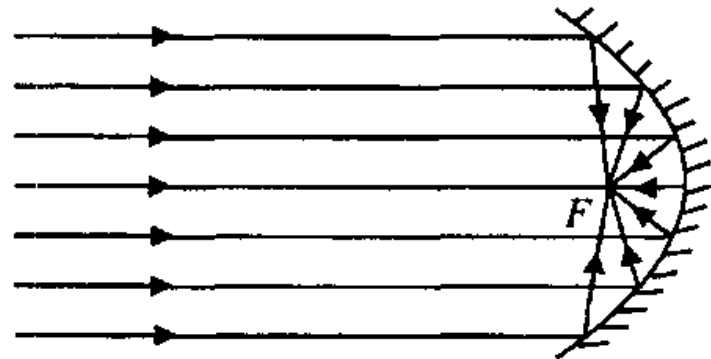

(b)

- Future Improvement on Parabolic Shape:
Compound Parabola

Design Choices

- **Paraboloid: Shallow vs. Deep**
Safety hazards, maneuverability
- **Paraboloid Dimensions: 3' x 4'**
Aluminum Sheeting
Focal Point: 10 in
Diameter: 33 in

Design Choices

- Still flexible
- More durable than cardboard
- Structural rigidity
- Preserving rectangular shape

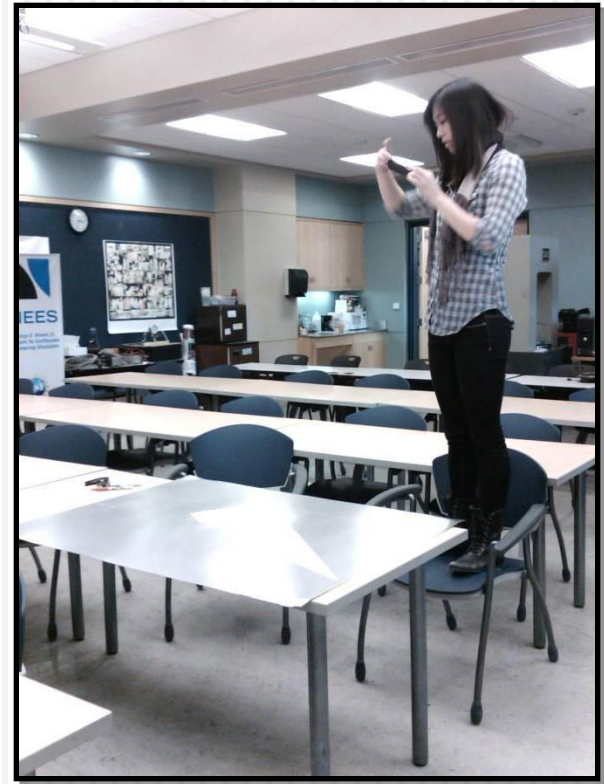

Construction: Paraboloid

row number	x	y	y1	z	Vd	from centre
1	0	0.00	0.26	5.11	5.11	1.01
2	5	0.26	1.04	5.16	10.27	2.03
3	10	1.04	2.34	5.26	15.53	3.04
4	15	2.34	4.16	5.42	20.94	4.06
5	20	4.16	6.50	5.61	26.56	5.07
6	26	6.50	9.36	5.85	32.40	6.09
7	31	9.36	12.74	6.12	38.52	7.10
8	36	12.74	16.65	6.42	44.94	8.12
9	41	16.65	21.07	6.75	51.69	9.13
10	46	21.07	26.01	7.10	58.80	10.14
11	51	26.01				
x increment	5.1	cm				
f (focal length)	25	cm				
sections	16	cm				

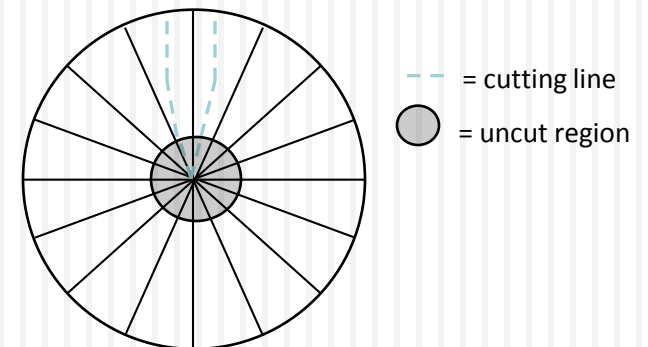
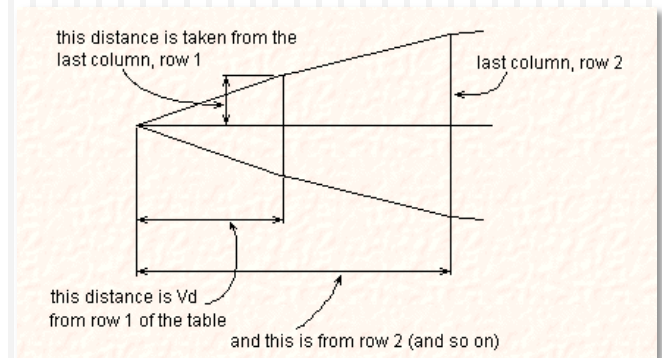

Construction: Paraboloid

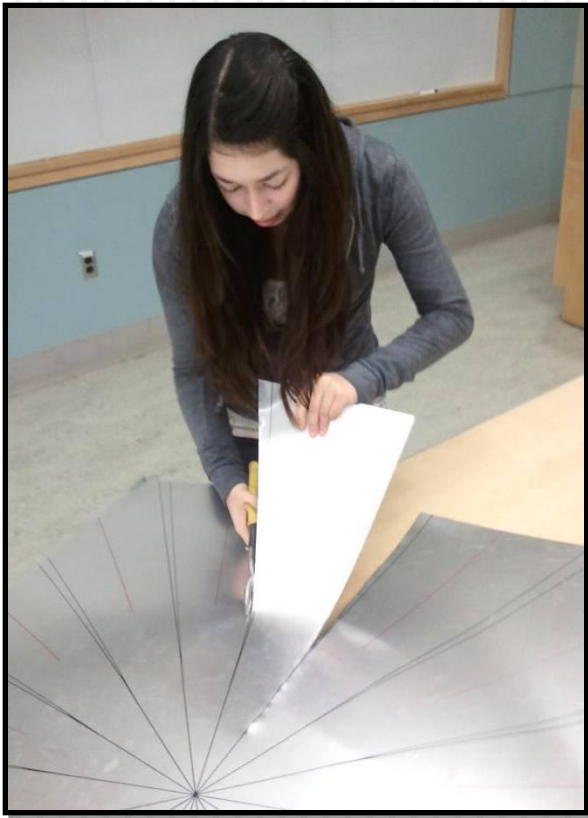

- Adhesive: reflective tape
- Cutting:
 - Inner diameter of 16 cm uncut
 - Petals overlap

Construction: Framework



Reflector and Framework

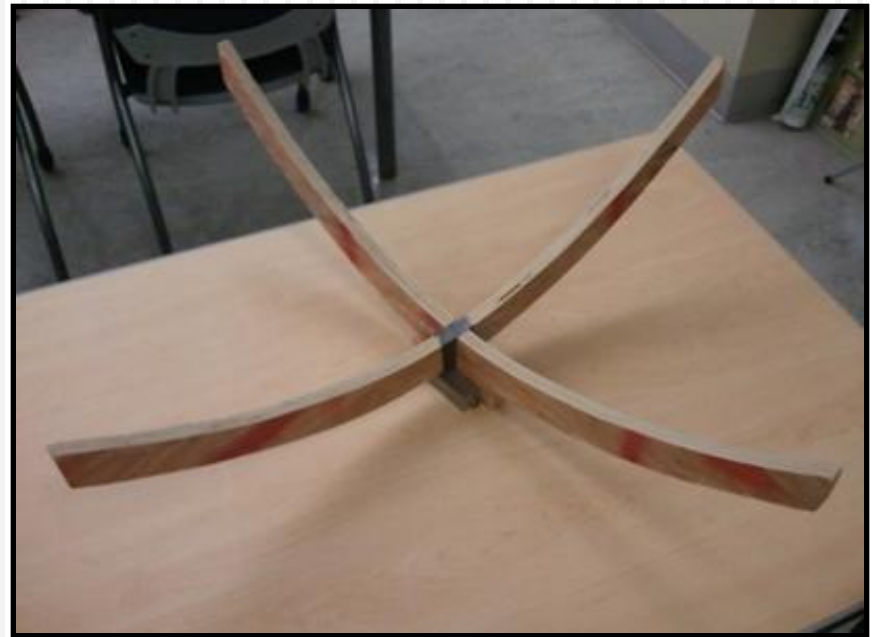

Reflector Support System

Results and Findings

Theoretical Focal Point: 9.8 in.

Actual Focal Point: 10 in.

- Needed to test max. temp. at focal point
- Tested system before framework had been constructed
 - Used wheelbarrow support system
 - Two tripods supported a wooden rod that held the thermocouple (recorded temperatures)

Results and Findings

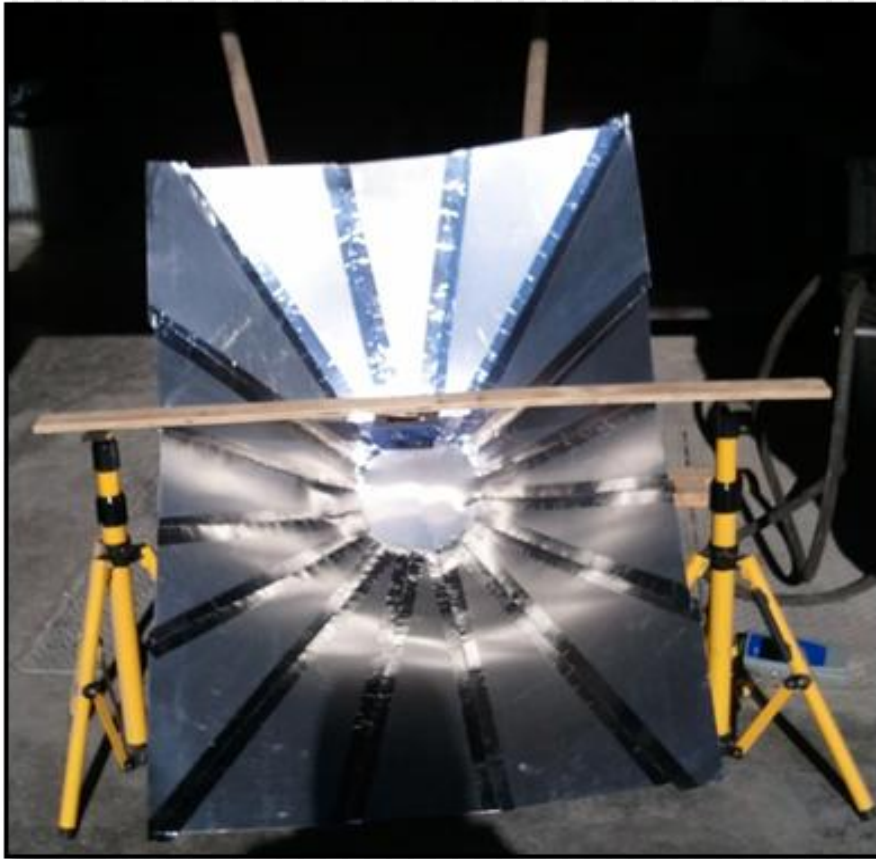

Concentrated Cooker Subteam

Results and Findings

- Peak temperature recorded: 145 Celsius
 - Comparable to current box-cookers
- Tape holding thermocouple melted and began recording ambient temp.
 - Needed better support system to test accurately
- No other successful attempts due to time constraint and lack of sunny days

Results and Findings

Parabolic Reflector Second Attempt

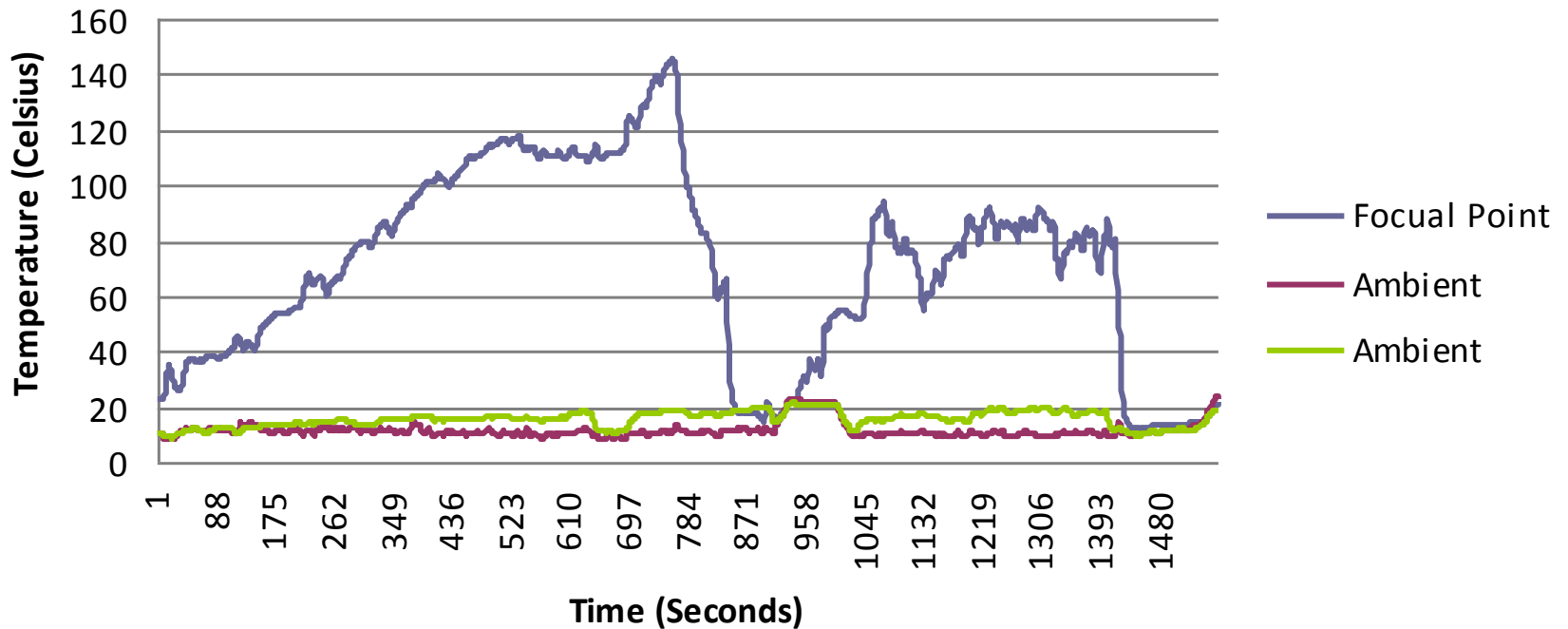

Discussion

- **Conclude that our prototype has potential to reach high temperatures needed to fry foods**
 - **Had failure not occurred, would have reached 250 Celsius**
 - **Need to find better supportive/adhesive material for thermocouple**
- **Design utilized materials already found in Winter Lab**

Discussion

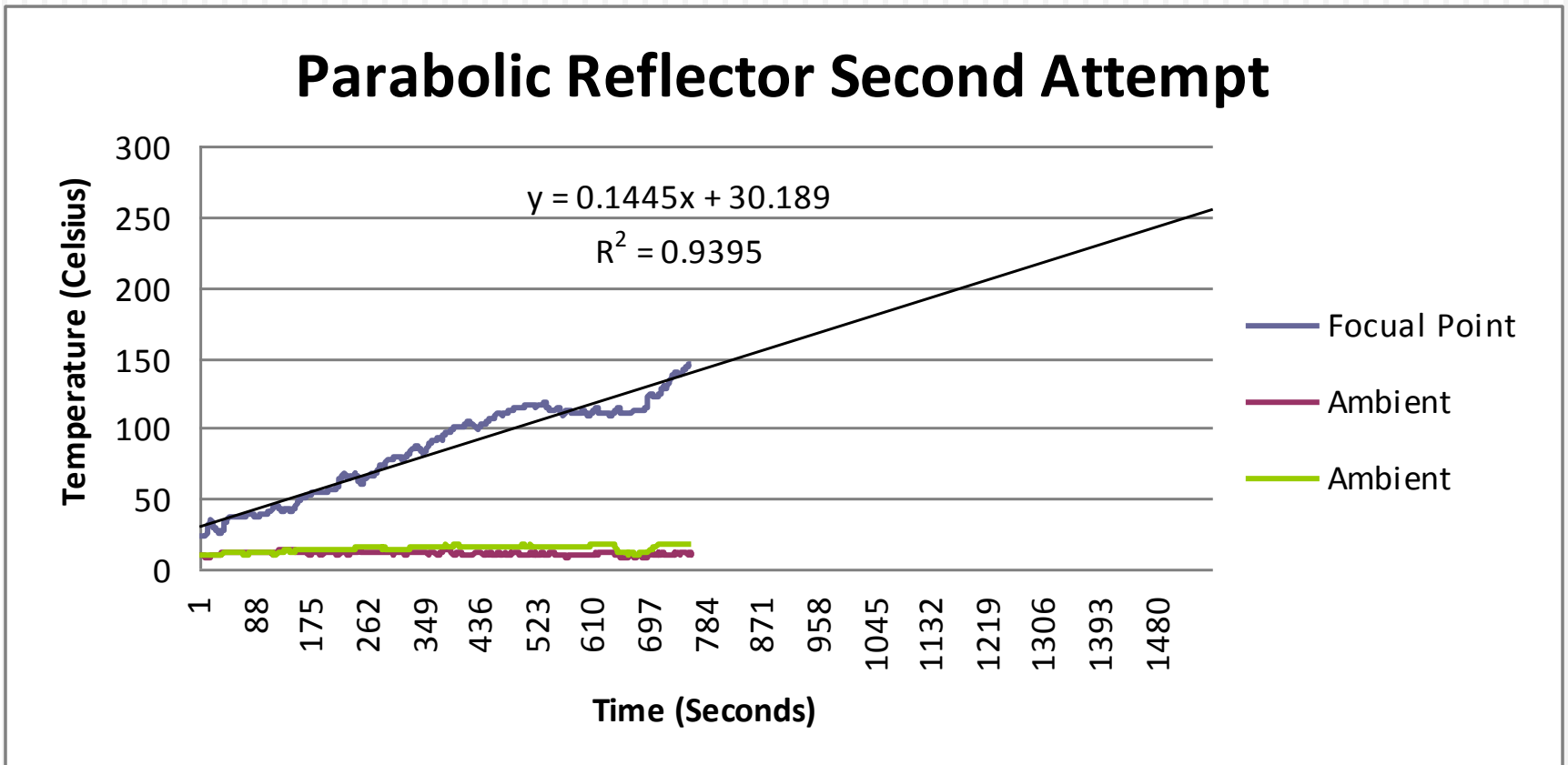

Criteria: Technical

- **Goal:**
 - Create a user-friendly design
 - Mobile to track the sun
 - Meet temperature requirements (250 C)
- User-friendly, mobile
- Testing to be continued
- Final cooking surface unfinished

Criteria: Social

- Goal:
 - Concrete temperature results
 - Demonstrate ability to fry food
 - Communicate results to organizations in Nicaragua to develop greater interest
- Maintained communication about our work on a parabolic reflector
- Positive feedback
- Recommend further informing once concrete testing data obtained

Criteria: Economic

- **Goal:**
 - **Materials chosen should be available to residents in Nicaragua (location, cost)**
 - **Purchased from local Nicaraguan businesses**
- **Reflector and framework made of aluminum and wood**
- **Both already used in solar box cookers**

Criteria: Environmental

- **Goal:**
 - **Zimmerman's 12 Principles of Green Engineering**
 - **Materials/energy inputs should be as renewable as possible**
- **Concentrated cooker = alternative to wood-burning stove**
- **Sunlight is the only energy input**

Recommendations for Future Teams

Compound Parabola

- Allows for greater concentration of light at focal point when light directed at angle
- Focus rays hitting at 30° angle
 - Two hours without adjustment

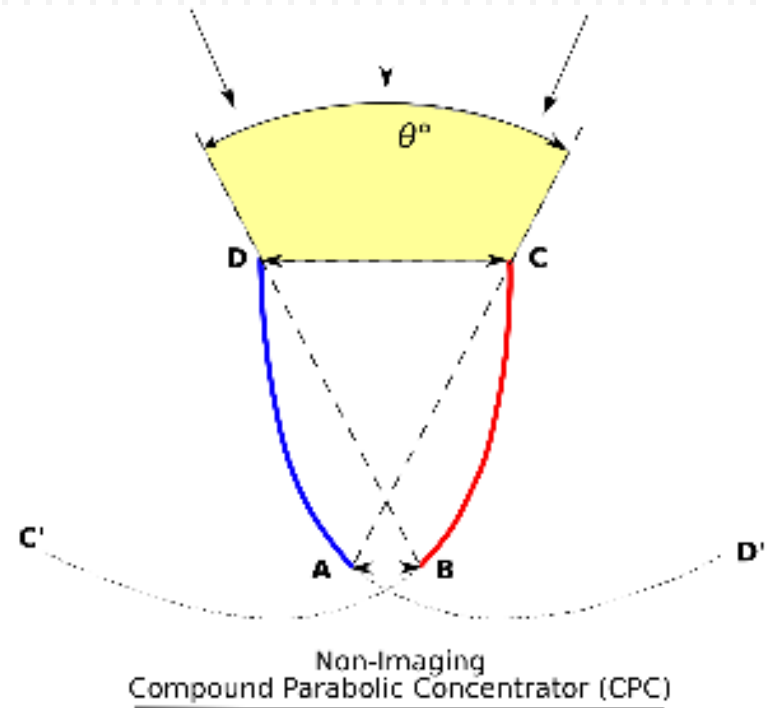

Conclusion

- Our cooker has potential to reach temp. hot enough to fry tortillas
 - More prototype testing next semester
 - Finish constructing cooking surface
- Grupo Fenix is interested in our cooker
 - Working on construction of restaurant to sell solar foods
- Introduction to Nicaragua in coming March

SMALL SOLAR OVEN

Joe Beaudette, Lauren Nielson, Leif Paulson, Rachel Philipson

Project Summary

The scope of our project is to design and build at least two solar ovens of smaller scale than the current design used in Nicaragua. The ovens will be optimized to work well in the Ithaca climate to be used in demonstration purposes locally. One oven will remain with the solar oven team, and one oven will be donated to the Cornell chapter of Engineers for a Sustainable World.

Construction

- Base our designs off of Nicaragua oven design and off of the small oven used by Professor Vanek
- Project timeline:
 - Design oven
 - Determine materials used
 - Build the ovens

Construction

- Utilizes a 45° solar collector (easily constructible)
- Fits three pots for cooking
- Can be carried by one person
- Uses double-pane glazing
- Latches on both sides of the door

Small Solar Oven Design

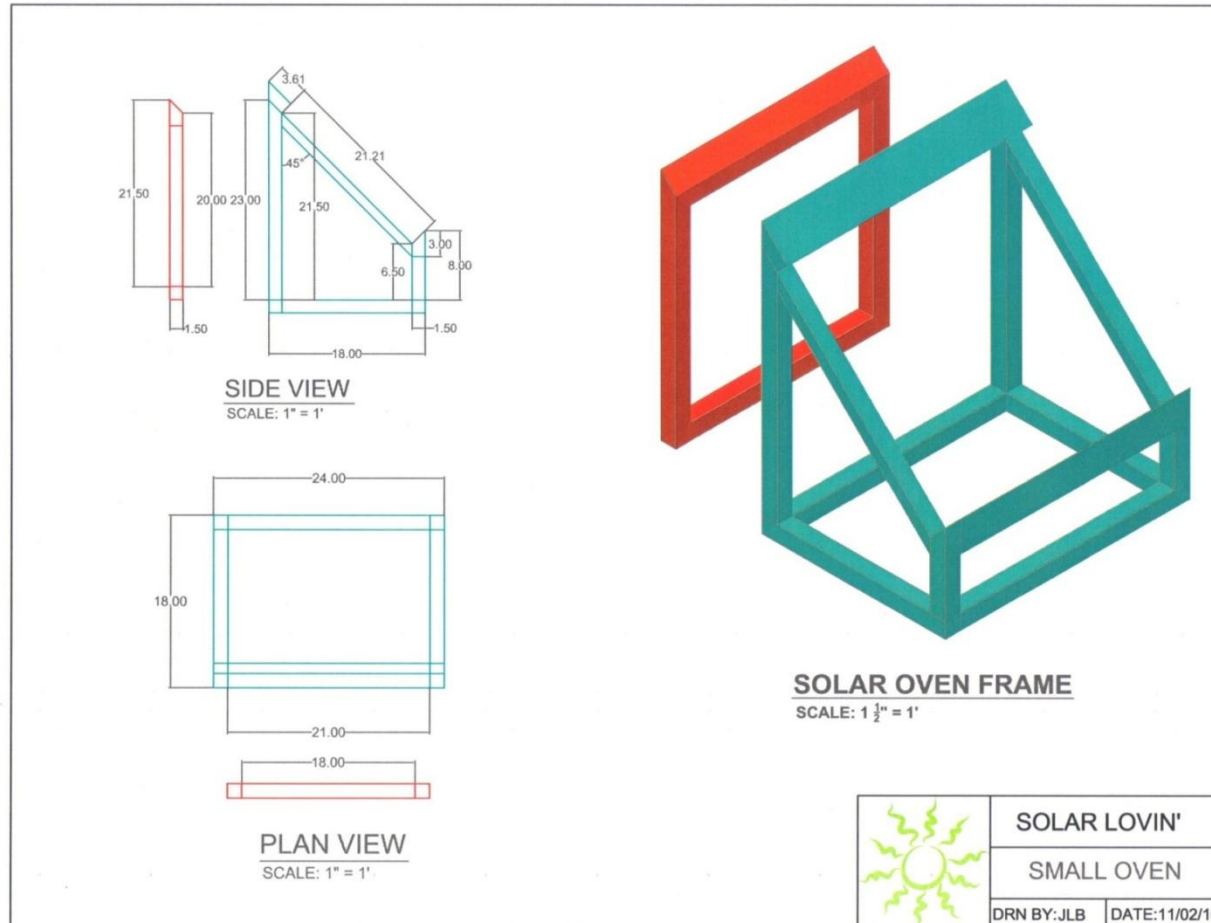

Construction

- **Materials:**
 - (1) Ripped 2x4 lumber for frame
 - (2) Fiberglass insulation
 - (3) Fiberboard interior support
 - (4) Thin metal film for reflective interior
 - (5) Double-pane glass

Construction

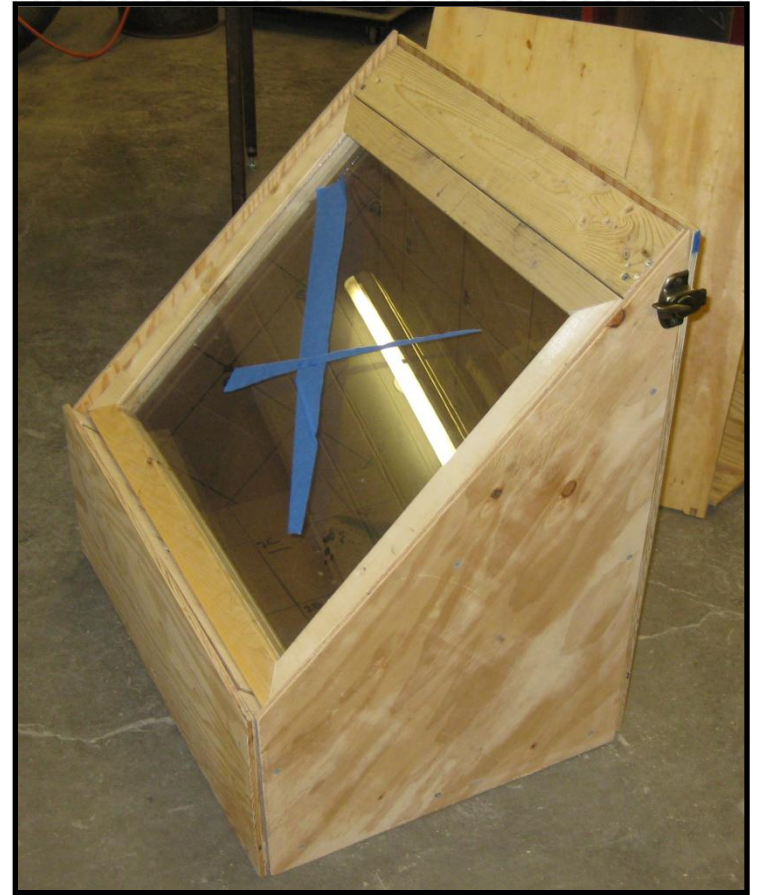

Small Solar Oven Subteam

Construction

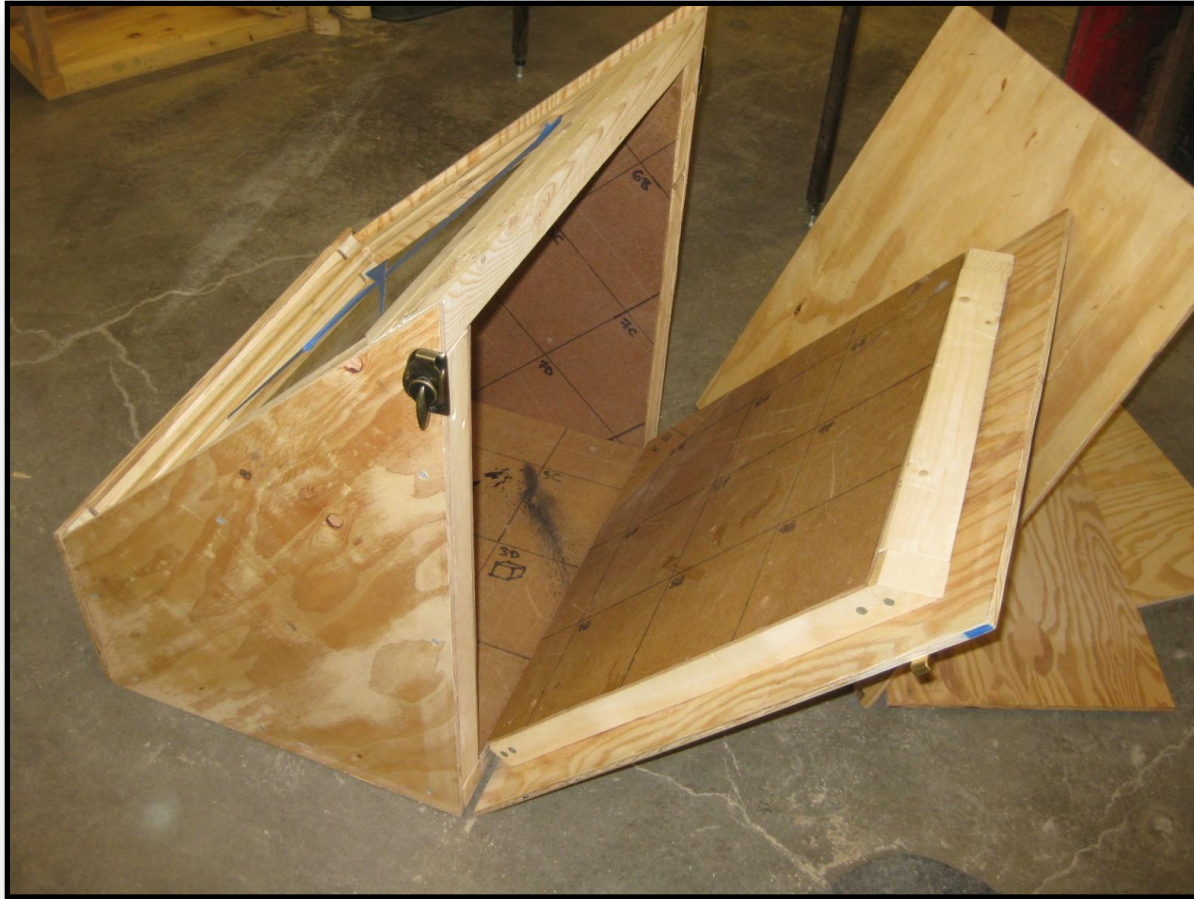

Small Solar Oven Subteam

Results and Findings

- Finished one of the smaller solar ovens
 - Second (for use by ESW chapter) is near completion
- Suggestions from Vanek were incorporated in final product
 - Latch rather than bungee cord
 - Taller to accommodate larger pots
 - Double glazing in removable window

Results and Findings

- One goal was to increase awareness
- Project incited interest in younger engineering students
- Smaller, angled ovens are intended for use in Northern part of world – namely Ithaca
 - Can be used for demonstration in this environmentally conscious community

Prop Rod Project

- Worked on new design for prop rods used in Nicaragua
 - Current prop rod is not sturdy and oven lid closes easily by wind
 - Has needed fixing for many semesters
- Old Design: Wooden bar, holes so user can select height and angle of lid
- New Design: Modeled off of power tool

Prop Rod Project

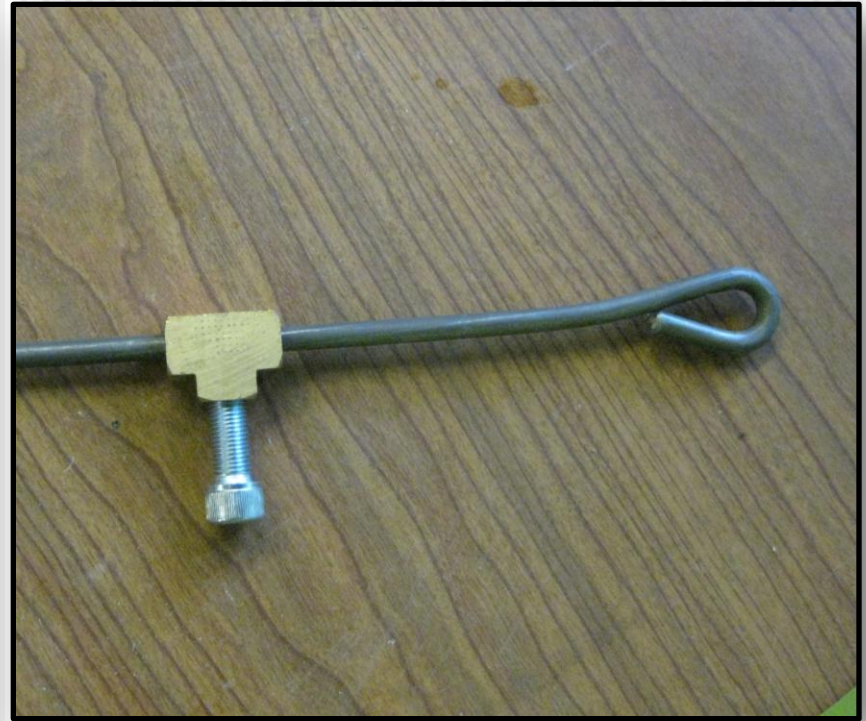

Criteria: Technical

- Small oven that can be transported by one person
- Altered for Ithaca solar elevation
- Reaches temperatures required for cooking
- Comparable materials to Nicaraguan ovens
- Robust design that will not break due to torque from wind
- Infinite oven heights/angles as opposed to discreet choices

Criteria: Social

- Promotion of the solar oven project in Ithaca, NY
 - Don't need to use artificial lighting
- Prop rod must be accepted by women
 - They requested the new design, won't have issues incorporating prop rod into oven design

Criteria: Economic

- Inexpensive, locally available materials
- Preferably same materials as used in Nicaraguan ovens
 - Other materials can be used to decrease costs
- Robust prop rod will not need to be replaced, thus decreasing costs

Criteria: Environmental

- Minimize energy use for cooking
 - Promotion will help make oven use more widespread
- Better prop rod design will increase lifetime of ovens and decrease resources used to make them

Recommendations for Future Teams

- Complete construction of the second oven
- Design and build a reflector panel system for the oven
- Develop a way to successfully test prop rod designs
- Retrofit old ovens with new prop rod design

Conclusion

- Devised several new prop rod designs
 - Easily retrofitted into Nicaraguan solar oven design
 - Testing will be completed next semester
- Design and construction of small solar ovens successful
 - Construction took more time than planned